



ROADS AND FLEET MANAGEMENT DEPARTMENT

TENDER NO. KWS/OT/R&F/35/2018–2019

**ROUTINE MAINTENANCE OF VOI TOWN-VOI GATE/VOI GATE-SALA –
GATE (E682)**

IN

TSAVO EAST NATIONAL PARK

May 2019

(Open to All)

**HEAD, ROADS AND FLEET MANAGEMENT,
KENYA WILDLIFE SERVICE,
P.O.BOX 40241 – 00100 ,
NAIROBI**

**DIRECTOR GENERAL,
KENYA WILDLIFE SERVICE,
P.O.BOX 40241 – 00100 ,
NAIROBI**

Sections of the Tender document

Invitation to Tender

Instruction to Tenderers

Appendix to Instruction to Tenderers

Form of Tender

Appendix to Form of Tender

Form of Tender Security

Schedules of Supplementary Information

Conditions of Contract of Particular Application

Conditions of Contract of Part 1: General Condition of Contract

Form of Agreement

Form of Performance Bank Guarantee (Unconditional)

Road Maintenance Manual

Specifications

Drawings

Bills of Quantities

Supervision and Contract Evaluation Manual

SECTION I
INVITATION TO TENDER



**Address: P.O.BOX 40241-00100
Nairobi**

INVITATION FOR TENDER

Tender Reference No. KWS/OT/R&F/35/2018-2019

Tender Name: Routine Maintenance of Voi-Voi Gate/Voi Gate-Sala Gate

Kenya Wildlife Service now invites eligible contractors to bid for the Works. Eligible contractors are those registered as road works contractors by the National Construction Authority (NCA) **Category 7 and above with current practising license** for the maintenance work for the above road in the **Tsavo East National Park**. The works are to be funded through the Fuel Levy Fund.

SCOPE OF WORK

The scope of works shall be as described in the tender document.

QUALIFICATION FOR TENDERING MANDATORY REQUIREMENTS

Eligible bidders must also submit the following among other eligibility requirements listed in the instruction to bidders;

- i) Certified Copy of Certificate of Incorporation/Business Registration name under the Companies Act.
- ii) A certified current copy of form CR12 for limited companies issued by the Registrar of Companies that clearly indicates the ownership of the companies (not older than 12 months).
- iii) Copy of a valid Tax Compliance Certificate from Kenya Revenue Authority (KRA) as at the date of tender closing.
- iv) Current annual NCA practicing licence for the specified category.
- v) A declaration that the bidder will not engage in any corrupt or fraudulent practice.
- vi) A declaration that the bidder or her sub-contractors are not debarred from participating in procurement proceedings by Public Procurement Regulatory Authority.
- vii) Original Tender Security **of Kshs 500,000 (Five hundred Thousand Shillings only)** issued in Kenya shillings or a freely convertible currency and in the form of bank guarantee or an insurance guarantee from insurance companies approved by PPRA / deposit taking microfinance institutions, SACCO societies, Youth Enterprise Development Fund or Women Enterprise Development Fund.
- viii) The Tender Security shall be in the **standard format** provided in the tender document and valid for a period of 120 days from the date of tender opening.

- ix) Bidders and their respective directors **can submit up to a maximum of two bids**, but from the **same national park or reserve**. Bidders and their respective directors submitting bids for **different parks and Reserves shall be disqualified.**
- x) There shall be **MANDATORY** organized **pre-tender site visit** on **19th June 2019**. Bidders shall assemble at **Voi Gate of Tsavo East National park at 9.00am**
- The attendance register and certificate of site visit shall be signed at the end of the pre-tender site visit by the bidder and witnessed by the KWS representative on the date of organized site visit.
 - Every bidder shall be represented by one person bearing a letter from the company authorizing them to represent the company in the pretender site visit. **One (1)** person shall only represent one company. The letter shall be in the official company letter head giving name and National Identification / Passport No. of the representative who shall be required to present their original identification during the pre-tender site visit.
- xi) Bidders having ongoing works with KWS that **have not been substantially completed** will not be eligible for bidding in this tender and will be disqualified.
- xii) The bidders shall comply with all the instructions of the tender and submit **a complete set of tender document as per the instruction to bidders Clause 9.1 and also ensure that all the forms required are properly filled for completeness**
- xiii) All the pages of bid document **MUST be serialized sequentially from cover page to the last page**. Bidders who fail to comply with this criterion will be disqualified.

Tender documents containing detailed specifications can be downloaded for free at our website; www.kws.go.ke.

Communication in regard to the tender must be in writing through email address: hps@kws.go.ke.

All clarifications and/or amendments will be published in KWS website and tenderers are required to check for any addendums or amendments in the course of the bidding period prior to the closing date.

The complete tenders enclosed in sealed envelopes clearly marked with the appropriate **Tender Number and Road Name** shall be submitted to:

**Director General,
Kenya Wildlife Service,
KWS, Headquarters, Langata Road,
P. O. Box 40241-00100,
NAIROBI, KENYA**

Or to be deposited in the Tender Box on Ground Floor, Main Reception on or **before 10.00am on Thursday, June 27, 2019**.

Opening of the Tenders will take place immediately thereafter in the KWS Conference Room in the presence of bidders representatives who wish to attend.

DIRECTOR GENERAL

SECTION II
INSTRUCTIONS TO TENDERERS

SECTION II - INSTRUCTION TO TENDERERS

Note: The tenderer must comply with the following conditions and instructions and failure to do so is liable to result in rejection of the tender.

GENERAL

1. Definitions

- (a) "Tenderer" means any persons, partnership firm or company submitting a sum or sums in the Bills of Quantities in accordance with the Instructions to Tenderers, Conditions of Contract Parts I and II, Specifications, Drawings and Bills of Quantities for the work contemplated, acting directly or through a legally appointed representative.
- (b) "Approved tenderer" means the tenderer who is approved by the Employer
- (c) Any noun or adjective derived from the word "tender" shall be read and construed to mean the corresponding form of the noun or adjective "bid". Any conjugation of the verb "tender" shall be read and construed to mean the corresponding form of the verb "bid."
- (d) "Employer" means a Central Government Ministry, Local Authority, State Corporation or any other Public Institution.

2. Eligibility and Qualification Requirements

2.1 Eligibility requirements

This invitation to tender is open to all bidders who are qualified and meet eligibility requirements stated in the appendix to Instruction to Tenderers (ITT).

2.2 Qualification Requirements

To be qualified for award of Contract, the tenderer shall provide evidence satisfactory to the Employer of their eligibility under Sub clause 2.1 above and of their capability and adequacy of resources to effectively carry out the subject Contract. To this end, the tenderer shall be required to update the following information already submitted during prequalification:-

- (a) Details of experience and past performance of the tenderer on the works of a similar nature and details of current work on hand and other contractual commitments.
- (b) The qualifications and experience of key personnel proposed for administration and execution of the contract, both on and off site.
- (c) Major items of construction plant and equipment proposed for use in carrying out the Contract. Only reliable plant in good working order and suitable for the work required of it shall be shown on this schedule. The tenderer will also indicate on this schedule when each item will be available on the Works. Included also should be a schedule of plant, equipment and material to be imported for the purpose of the Contract, giving details of make, type, origin and CIF value as appropriate.

- (d) Details of sub-contractors to whom it is proposed to sublet any portion of the Contract and for whom authority will be requested for such subletting in accordance with clause 4 of the Condition of Contract.
- (e) A draft Program of Works in the form of a bar chart and Schedule of Payment which shall form part of the Contract if the tender is accepted. Any change in the Program or Schedule shall be subjected to the approval of the Engineer.
- (f) Details of any current litigation or arbitration proceedings in which the tenderer is involved as one of the parties.

2.3 Joint Ventures

Tenders submitted by a joint venture of two or more firms as partners shall comply with the following requirements:-

- (a) The tender, and in case of a successful tender, the Form of Agreement, shall be signed so as to be legally binding on all partners
- (b) One of the partners shall be nominated as being in charge, and this authorization shall be evidenced by submitting a power of attorney signed by legally authorized signatories of all the partners
- (c) The partner in charge shall be authorized to incur liabilities and receive instructions for an on behalf of any and all partners of the joint venture and the entire execution of the Contract including payment shall be done exclusively with the partner in charge.
- (d) All partners of the joint venture shall be liable jointly and severally for the execution of the Contract in accordance with the Contract terms, and a relevant statement to this effect shall be included in the authorization mentioned under (b) above as well as in the Form of Tender and the Form of Agreement (in case of a successful tender)
- (e) A copy of the agreement entered into by the joint venture partners shall be submitted with the tender.

3. Cost of Tendering

- 3.1 The Tenderer shall bear all costs associated with the preparation and submission of his tender and the Employer will in no case be responsible or liable for those costs, regardless of the conduct or outcome of the tendering process.
- 3.2 A complete set of tender documents may be obtained free of charge from Kenya Wildlife Website: www.kws.go.ke or through the link <http://www.kws.go.ke/info/tenders.html>.

4. Site Visit

- 4.1. The tenderer is advised to visit and examine the Site and its surroundings and obtain for himself on his own responsibility, all information that may be necessary for preparing the tender and entering into a contract. The costs of visiting the Site shall be the tenderer's own responsibility
- 4.2. The tenderer and any of his personnel or agents will be granted permission by the Employer to enter upon premises and lands for the purpose of such inspection, but only upon the express condition that the tenderer, his personnel or agents, will release and indemnify the Employer from and against all liability in respect of, and will be responsible for personal injury (whether fatal or otherwise), loss of or damage to property and any other loss, damage, costs and expenses however caused, which but for the exercise of such permission, would not have arisen.
- 4.3. The Employer shall organize a site visit at a date and venue to be notified. A representative of the Employer will be available to meet the intending tenderers at the Site. Tenderers must provide their own transport. The representative will not be available at any other time for site inspection visits.
- 4.4. Each tenderer shall sign the attendance register and certificate of Site visit at the time of the organized site visit.
- 4.5. Bidders who participated in the organized pretender site visit can revisit the site later at their own time and cost with prior arrangement with the park management.

TENDER DOCUMENTS

5 Tender Documents

5.1 The Tender documents comprise the documents listed here below and should be read together with any Addenda issued in accordance with Clause 7 of these instructions to tenderers.

- a. Form of Invitation for Tenders
- b. Instructions to Tenderers
- c. Form of Tender
- d. Appendix to Form of Tender
- e. Form of Tender Surety
- f. Statement of Foreign Currency Requirements
- g. Schedules of Supplementary Information
- h. Details of Sub contractors
- i. General Conditions of Contract – Part I
- j. Conditions of Particular Application – Part II
- k. Specifications
- l. Bills of Quantities
- m. Drawings
- n. Declaration Form

5.2 The tenderer is expected to examine carefully all instructions, conditions, forms, terms, specifications and drawings in the tender documents. Failure to comply with the requirements for tender submission will be at the tenderer's own risk. Pursuant to clause 22 of Instructions to Tenderers, tenders which are not substantially responsive to the requirements of the tender documents will be rejected.

5.3 All recipients of the documents for the proposed Contract for the purpose of submitting a tender (whether they submit a tender or not) shall treat the details of the documents as "private and confidential".

6 Inquiries by tenderers

6.1 A tenderer making an inquiry relating to the tender document may notify the Employer in writing or by email at the Employer's mailing address indicated in the Invitation to Tender. The Employer will respond in writing to any request for clarification which he receives earlier than 7 days prior to the deadline for the submission of tenders. Written copies of the Employer's response (including the query but without identifying the source of the inquiry) will be sent to all prospective tenderers who have purchased the tender documents.

6.2 The procuring entity shall reply to any clarifications sought by the tenderer within 3 days of receiving the request to enable the tenderer to make timely submission of its tender.

7 Amendment of Tender Documents

7.1 At any time prior to the deadline for submission of tenders the Employer may, for any reason, whether at his own initiative or in response to a clarification requested by a prospective tenderer, modify the tender documents by issuing Addenda.

7.2 Any Addendum will be notified in writing or by e-mail or through the KWS website to all prospective tenderers and will be binding upon them.

7.3 In order to allow prospective tenderers reasonable time in which to take the Addendum into account in preparing their tenders, the Employer may, at his discretion, extend the deadline for the submission of tenders.

PREPARATION OF TENDERS

8 Language of Tender

- 8.1 The tender and all correspondence and documents relating to the tender exchanged between the tenderer and the Employer shall be written in the English language. Supporting documents and printed literature furnished by the tenderer with the tender may be in another language provided they are accompanied by an appropriate translation of pertinent passages in the above stated language. For the purpose of interpretation of the tender, the English language shall prevail.

9 Documents Comprising the Tender

- 9.1 The tender to be prepared by the tenderer shall comprise:
- i) the Form of Tender and Appendix thereto,
 - ii) a Tender Security
 - iii) the Priced Bills of Quantities and Schedules
 - iv) the information on eligibility and qualification
 - v) Any other materials required to be completed and submitted in accordance with the Instructions to Tenderers.

The Forms, Bills of Quantities and Schedules provided in the tender documents shall be used without exception (subject to extensions of the schedules in the same format and to the provisions of clause 13.2 regarding the alternative forms of Tender Surety).

10 Tender Prices

- 10.1 All the insertions made by the tenderer shall be made in INK and the tenderer shall clearly form the figures. The relevant space in the Form of Tender and Bills of Quantities shall be completed accordingly without interlineations or erasures except those necessary to correct errors made by the tenderer in which case the erasures and interlineations shall be initialled by the person or persons signing the tender.
- 10.2 A price or rate shall be inserted by the tenderer for every item in the Bills of Quantities whether the quantities are stated or not. Items against which no rate or price is entered by the tenderer will not be paid for by the Employer when executed and shall be deemed covered by the rates for other items and prices in the Bills of Quantities.

The prices and unit rates in the Bills of Quantities are to be the full [all-inclusive] value of the Work described under the items, including all costs and expenses which may be necessary and all general risks, liabilities and obligations set forth or implied in the documents on which the tender is based. All duties, taxes and other levies payable by the Contractor under the Contract, or for any other cause prior to the deadline for submission of tenders, shall be included in the rates and prices and the total Tender Price submitted by the tenderer.

Each price or unit rate inserted in the Bills of Quantities should be a realistic estimate for completing the activity or activities described under that particular item and the tenderer is advised against inserting a price or rate against any item contrary to this instruction.

Every rate entered in the Bills of Quantities, whether or not such rate be associated with a quantity, shall form part of the Contract. The Employer shall have the right to call for any item of work contained in the Bills of Quantities, and such items of work to be paid for at the rate entered by the tenderer and it is the intention of the Employer to take full advantage of unbalanced low rates.

- 10.3 Unless otherwise specified the tenderer must enter the amounts representing 10% of the sub-total of the summary of the Bills of Quantities for Contingencies and Variation of Prices[V.O.P.] payments in the summary sheet and add them to the sub-total to arrive at the tender amount.
- 10.4 The tenderer shall furnish with his tender written confirmation from his suppliers or manufacturers of basic unit rates for the supply of items listed in the Conditions of Contract clause 70 where appropriate. The Employer may require the tenderer to justify such rates so obtained from the suppliers or manufacturers.
- 10.5 The rates and prices quoted by the tenderer are subject to adjustment during the performance of the Contract only in accordance with the Provisions of the Conditions of Contract. The tenderer shall complete the schedule of basic rates and shall submit with his tender such other supporting information as required under clause 70 of the Conditions of Contract Part II.
- 10.6 Contract price variations shall not be allowed within the first 12 months of the contract.
- 10.7 Where quantity contract variation is allowed, the variation shall not exceed 25% of the original contract quantity.
- 10.8 Price variation requests shall be processed by the procuring entity within 30 days of receiving the request.

11 Currencies of Tender and Payment

- 11.1 Tenders shall be priced in **Kenya Shillings** and the tender sum shall be in **Kenya Shillings**.
- 11.2 Tenderers are required to indicate in the Statement of Foreign Currency Requirements, which forms part of the tender, the foreign currency required by them. Such currency should generally be the currency of the country of the tenderer's main office. However, if a substantial portion of the tenderer's expenditure under the Contract is expected to be in countries other than his country of origin, then he may state a corresponding portion of the contract price in the currency of those other countries. However, the foreign currency element is to be limited to two (2) different currencies and a maximum of 30% (thirty percent) of the Contract Price.
- 11.3 The rate or the rates of exchange used for pricing the tender shall be the selling rate or rates of the Central Bank ruling on the date thirty (30) days before the final date for the submission of tenders.

11.4 Tenderers must enclose with their tenders, a brief justification of the foreign currency requirements stated in their tenders.

12 Tender Validity

12.1 The tender shall remain valid and open for acceptance for a period of ninety (90) calendar days from the specified date of tender opening or from the extended date of tender opening (in accordance with clause 7.3 here above) whichever is the later.

12.2 In exceptional circumstances prior to expiry of the original tender validity period, the Employer may request the tenderer for a specified extension of the period of validity. The request and the responses there to shall be made in writing or by email or through the KWS website and advert through local daily newspapers. A tenderer may refuse the request without forfeiting his Tender Surety. A tenderer agreeing to the request will not be required nor permitted to modify his tender, but will be required to extend the validity of his Tender Surety correspondingly.

13 Tender Security

13.1 The tenderer shall furnish as part of his tender, a Tender Security in the amount and form stated in the Appendix to Instructions to Tenderers.

13.2 The Tender Security shall be valid at least thirty (30) days beyond the tender validity period.

13.3 Any tender not accompanied by an acceptable Tender Surety will be rejected by the Employer as non-responsive.

13.4 The Tender Sureties of unsuccessful tenderers will be returned as promptly as possible as but not later than twenty eight (28) days after expiration of the tender validity period. The Tender Surety of the successful tenderer will be returned upon the tenderer executing the Contract and furnishing the required Performance Security.

13.5 The Tender Surety may be forfeited:

- a) If a tenderer withdraws his tender during the period of tender validity: or
- b) in the case of a successful tenderer, if he fails, within the specified time limit
 - i. to sign the Agreement, or
 - ii. to furnish the necessary Performance Security
- c) If a tenderer does not accept the correction of his tender price pursuant to clause 23.

14 No Alternative Offers

14.1 The tenderer shall submit an offer which complies fully with the requirements of the tender documents unless otherwise provided for in the appendix.

Only one tender may be submitted by each tenderer either by himself or as partner in a joint venture. A tenderer who submits or participates in more than one tender will be disqualified.

14.2 The tenderer shall not attach any conditions of his own to his tender. The tender price must be based on the tender documents. The tenderer is not required to present alternative construction

options and he shall use without exception, the Bills of Quantities as provided, with the amendments as notified in tender notices, if any, for the calculation of his tender price. Any tenderer who fails to comply with this clause will be disqualified.

15 Pre-tender Meeting

15.1 If a pre-tender meeting is convened, the tenderer's designated representative is invited to attend at the venue and time in the Invitation to Tender. The purpose of the meeting will be to clarify issues and to answer questions on any matter that may be raised at that stage.

15.2 The tenderer is requested as far as possible to submit any questions in writing or by email, to reach the Employer not later than seven (7) days before the meeting. It may not be practicable at the meeting to answer questions received late, but questions and responses will be transmitted in accordance with the following:

- (a) Minutes of the meeting, including the text of the questions raised and the responses given together with any responses prepared after the meeting, will be transmitted without delay to all purchasers of the tender documents. Any modification of the tender documents listed in – Clause 9 which may become necessary as a result of the pre-tender meeting shall be made by the Employer exclusively through the issue of a tender notice pursuant to Clause 7 and not through the minutes of the pre-tender meeting.
- (b) Non attendance at the pre-bid meeting will not be cause for disqualification of a bidder.

16 Format and Signing of Tenders

16.1 The tenderer shall prepare his tender as outlined in clause 9 above and mark appropriately one set "ORIGINAL" and the other "COPY".

16.2 The copy of the tender and Bills of Quantities shall be typed or written in indelible ink and shall be signed by a person or persons duly authorized to sign on behalf of the tenderer. All pages of the tender where amendments have been made shall be initialled by the person or persons signing the tender.

16.3 The complete tender shall be without alterations, interlineations or erasures, except as necessary to correct errors made by the tenderer, in which case such corrections shall be initialled by the person or persons signing the tender.

SUBMISSION OF TENDERS

17 Tender format, Sealing and Marking of Tenders

- 17.1** The tenderer shall seal the original and copy of the tender in separate envelopes, duly marking the envelopes as “ORIGINAL” and “COPY”. The envelopes shall then be sealed in an outer separate envelope. The **copy** shall be a replica of the **Original**.
- 17.2** The inner and outer envelopes shall be addressed to the Employer at the address stated in the Appendix to Instructions to Tenderers and bear the name and identification of the Contract stated in the said Appendix with a warning not to open before the date and time for opening of tenders stated in the said Appendix.
- 17.3** The inner envelopes shall each indicate the name and address of the tenderer to enable the tender to be returned unopened in case it is declared “late”, while the outer envelope shall bear no mark indicating the identity of the tenderer.
- 17.4** If the outer envelope is not sealed and marked as instructed above, the Employer will assume no responsibility for the misplacement or premature opening of the tender. A tender opened prematurely for this cause will be rejected by the Employer and returned to the tenderer.

18 Deadline for Submission of Tenders

- 18.1** Tenders must be received by the Employer at the address specified in clause 17.2 and on the date and time specified in the Letter of Invitation, subject to the provisions of clause 7.3, 18.2 and 18.3.
- Tenders delivered by hand must be placed in the “tender box” provided in the office of the Employer. Proof of posting will not be accepted as proof of delivery and any tender delivered after the above stipulated time, from whatever cause arising will not be considered.
- 18.2** The Employer may, at his discretion, extend the deadline for the submission of tenders through the issue of an Addendum in accordance with clause 7, in which case all rights and obligations of the Employer and the tenderers previously subject to the original deadline shall thereafter be subject to the new deadline as extended.
- 18.3** Any tender received by the Employer after the prescribed deadline for submission of tender will be returned unopened to the tenderer.

19 Modification and Withdrawal of Tenders

- 19.1** The tenderer may modify or withdraw his tender after tender submission, provided that written notice of the modification or withdrawal is received by the Employer prior to the prescribed deadline for submission of tenders.
- 19.2** The tenderer's modification or withdrawal notice shall be prepared, sealed, marked and dispatched in accordance with the provisions for the submission of tenders, with the inner and outer envelopes additionally marked "MODIFICATION" or "WITHDRAWAL" as appropriate.
- 19.3** No tender may be modified subsequent to the deadline for submission of tenders.
- 19.4** No tender may be withdrawn in the interval between the deadline for submission of tenders and the period of tender validity specified on the tender form. Withdrawal of a tender during this interval will result in the forfeiture of the Tender Surety.
- 19.5** Subsequent to the expiration of the period of tender validity prescribed by the Employer, and the tenderer having not been notified by the Employer of the award of the Contract or the tenderer does not intend to conform with the request of the Employer to extend the period of tender validity, the tenderer may withdraw his tender without risk of forfeiture of the Tender Surety.

TENDER OPENING AND EVALUATION**20 Tender Opening**

- 20.1** The Employer will open the tenders in the presence of the tenderers' representatives who choose to attend at the time and location indicated in the Letter of Invitation to Tender. The tenderers' representatives who are present shall sign a register evidencing their attendance.
- 20.2** Tenders for which an acceptable notice of withdrawal has been submitted, pursuant to clause 19, will not be opened. The Employer will examine the tenders to determine whether they are complete, whether the requisite Tender Sureties have been furnished, whether the documents have been properly signed and whether the tenders are generally in order.
- 20.3** At the tender opening, the Employer will announce the tenderer's names, total tender price, tender price modifications and tender withdrawals, if any, the presence of the requisite Tender Surety and such other details as the Employer, at his discretion, may consider appropriate. No tender shall be rejected at the tender opening except for late tenders.
- 20.4** The Employer shall prepare minutes of the tender opening including the information disclosed to those present.
- 20.5** Tenders not opened and read out at the tender opening shall not be considered further for evaluation, irrespective of the circumstances.

21 Process to be Confidential

- 21.1** After the public opening of tenders, information relating to the examination, clarification, evaluation and comparisons of tenders and recommendations concerning the award of Contract shall not be disclosed to tenderers or other persons not officially concerned with such process until the award of Contract is announced.
- 21.2** Any effort by a tenderer to influence the Employer in the process of examination, evaluation and comparison of tenders and decisions concerning award of Contract may result in the rejection of the tenderer's tender.

22 Clarification of Tenders

- 22.1** To assist in the examination, evaluation and comparison of tenders, the Employer may ask tenderers individually for clarification of their tenders, including breakdown of unit prices. The request for clarification and the response shall be in writing or by email, but no change in the price or substance of the tender shall be sought, offered or permitted except as required to confirm the correction of arithmetical errors discovered by the employer during the evaluation of the tenders in accordance with clause 24.
- 22.2** No tenderer shall contact the Employer on any matter relating to his tender from the time of the tender opening to the time the Contract is awarded. If the tenderer wishes to bring additional information to the notice of the Employer, he shall do so in writing.

23 Determination of Responsiveness

- 23.1** Prior to the detailed evaluation of tenders, the Employer will determine whether each tender is substantially responsive to the requirements of the tender documents. KWS's determination of a Tender's responsiveness is to be based on the contents of the Tender itself without recourse to extrinsic evidence.
- 23.2** For the purpose of this clause, a substantially responsive tender is one which conforms to all the terms, conditions and specifications of the tender documents without material deviation or reservation. A material deviation or reservation is one which affects in any substantial way the scope, quality, completion timing or administration of the Works to be undertaken by the tenderer under the Contract, or which limits in any substantial way, inconsistent with the tender documents, the Employer's rights or the tenderers obligations under the Contract and the rectification of which would affect unfairly the competitive position of other tenderers who have presented substantially responsive tenders.
- 23.3** Each price or unit rate inserted in the Bills of Quantities shall be a realistic estimate of the cost of completing the works described under the particular item including allowance for overheads, profits and the like. Should a tender be seriously unbalanced in relation to the Employer's estimate of the works to be performed under any item or groups of items, the tender shall be deemed not responsive.
- 23.4** A tender determined to be not substantially responsive will be rejected by the Employer and may not subsequently be made responsive by the tenderer by correction of the non-conforming deviation or reservation.
- 23.5** Post-qualification criteria are as provided in the Appendix to instruction to tenderers.

24 Correction of Errors

Tenders determined to be substantially responsive shall be checked by the Employer for any arithmetic errors in the computations and summations. Errors will be corrected by the Employer as follows:

- (a) Where there is a discrepancy between the amount in figures and the amount in words, the amount in words will govern.
- (b) Where there is a discrepancy between the unit rate and the line item total resulting from multiplying the unit rate by the quantity, the unit rate as quoted will prevail, unless in the opinion of the Employer, there is an obvious typographical error, in which case adjustment will be made to the entry containing that error.
- (c) In the event of a discrepancy between the tender amount as stated in the Form of Tender and the corrected tender figure in the main summary of the Bills of Quantities, the amount as stated in the Form of Tender shall prevail.
- (d) The Error Correction Factor shall be computed by expressing the difference between the tender amount and the corrected tender sum as a percentage of the corrected builder's work (i.e. corrected tender sum less Prime Cost and Provisional Sums).

- (e) The Error Correction Factor shall be applied to all builder's work (as a rebate or addition as the case may be) for the purposes of valuations for Interim Certificates and valuations of variations.
- (f) The amount stated in the tender will be adjusted in accordance with the above procedure for the correction of errors and, with concurrence of the tenderer, shall be considered as binding upon the tenderer. If the tenderer does not accept the corrected amount, the tender may be rejected and the Tender Security may be forfeited in accordance with clause 13.

25 Conversion to Single Currency

- 25.1** For compensation of tenders, the tender price shall first be broken down into the respective amounts payable in various currencies by using the selling rate or rates of the Central Bank of Kenya ruling on the date twenty one (21) days before the final date for the submission of tenders.
- 25.2** The Employer will convert the amounts in various currencies in which the tender is payable (excluding provisional sums but including Day works where priced competitively) to Kenya Shillings at the selling rates stated in clause 25.1.

26 Evaluation and Comparison of Tenders

- 26.1** The Employer will evaluate only tenders determined to be substantially responsive to the requirements of the tender documents in accordance with clause 23.
- 26.2** In evaluating tenders, the Employer will determine for each tender the evaluated tender price by adjusting the tender price as follows:
- (a) Making any correction for errors pursuant to clause 24.
 - (b) Excluding Provisional Sums and provision, if any, for Contingencies in the Bills of Quantities, but including Day works where priced competitively.
- 26.3** The Employer reserves the right to accept any variation, deviation or alternative offer. Variations, deviations, alternative offers and other factors which are in excess of the requirements of the tender documents or otherwise result in the accrual of unsolicited benefits to the Employer, shall not be taken into account in tender evaluation.
- 26.4** Price adjustment provisions in the Conditions of Contract applied over the period of execution of the Contract shall not be taken into account in tender evaluation.
- 26.5** If the lowest evaluated tender is seriously unbalanced or front loaded in relation to the Employer's estimate of the items of work to be performed under the Contract, the Employer may require the tenderer to produce detailed price analyses for any or all items of the Bills of Quantities, to demonstrate the relationship between those prices, proposed construction methods and schedules. After evaluation of the price analyses, the Employer may require that the amount of the Performance Security set forth in clause 29 be increased at the expense of the successful tenderer to a level sufficient to protect the Employer against financial loss in the event of subsequent default of the successful tenderer under the Contract.

-
- 26.6** Firms incorporated in Kenya where indigenous Kenyans own 51% or more of the share capital shall be allowed a 10% preferential bias provided that they do not sub-contract work valued at more than 50% of the Contract Price excluding provisional sums to a non-indigenous sub-contractor.
- 26.7** Preference where allowed in the evaluation of tenders shall not exceed 15%
- 26.8** The procuring entity may at any time terminate procurement proceedings before contract award and shall not be liable to any person for the termination.
- 26.9** The procuring entity shall give prompt notice of the termination to the tenderers and on request give its reasons for termination within 14 days of receiving the request from any tenderer.
- 26.10** A tenderer who gives false information in the tender document about its qualification or who refuses to enter into a contract after notification of contract award shall be considered for debarment from participating in future public procurement.
- 26.11** Poor past performance shall not be used as an evaluation criteria unless specifically provided for in the appendix.

AWARD OF CONTRACT**27. Award Criteria**

- 27.1 Subject to Sub-clause 27.2, the Employer will award the Contract to the tenderer whose tender is determined to be substantially responsive to the tender documents and who has offered the lowest evaluated tender price subject to possessing the capability and resources to effectively carry out the Contract Works as required in Sub-clause 2.1 and 2.2 here above.
- 27.2 The Employer reserves the right to accept or reject any tender, and to annul the tendering process and reject all tenders, at any time prior to award of Contract, without thereby incurring any liability to the affected tenderers or any obligation to inform the affected tenderers of the grounds for the Employer's action.

28 Notification of Award

- 28.1 Prior to the expiration of the period of tender validity prescribed by the Employer, the Employer will notify the successful tenderer by cable, telefax or telex and confirmed in writing by registered letter that his tender has been accepted. This letter (hereinafter and in all Contract documents called "Letter of Acceptance") shall name the sum (hereinafter and in all Contract documents called "the Contract Price") which the Employer will pay to the Contractor in consideration of the execution and completion of the Works as prescribed by the Contract.
- 28.2 At the same time that the Employer notifies the successful tenderer that his tender has been accepted, the Employer shall notify the other tenderers that the tenders have been unsuccessful.
- 28.3 Within fourteen [14] days of receipt of the Form of Contract Agreement from the Employer, the successful tenderer shall sign the form and return it to the Employer together with the required Performance Security.
- 28.4 The parties to the contract shall have it signed within 30 days from the date of notification of contract award unless there is an administrative review request.

29 Performance Guarantee

- 29.1 Within twenty eight [28] days of receipt of the notification of award from the Employer, the successful tenderer shall furnish the Employer with a Performance Security in the amount stated in the Appendix to Instructions to Tenderers and in the format stipulated in the Conditions of Contract.
- 29.2 The Performance Security to be provided by the successful tenderer shall be an unconditional Bank Guarantee issued at the tenderer's option by a reputable Bank approved by the Employer and located in the Republic of Kenya and shall be divided into two elements namely, a performance security payable in foreign currencies (based upon the exchange rates determined in accordance with clause 60(5) of the Conditions of Contract) and a performance security payable in Kenya Shillings. The value of the two securities shall be in the same proportions of foreign and local currencies as requested in the form of foreign currency requirements.

29.3 Failure of the successful tenderer to lodge the required Performance Security shall constitute a breach of Contract and sufficient grounds for the annulment of the award and forfeiture of the Tender Security and any other remedy under the Contract. The Employer may award the Contract to the next ranked tenderer.

30 Advance Payment

An advance payment, if approved by the Employer, shall be made under the Contract, if requested by the Contractor, in accordance with clause 60(1) of the Conditions of Contract. The Advance Payment Guarantee shall be denominated in the proportion and currencies named in the form of foreign currency requirements. For each currency, a separate guarantee shall be issued. The guarantee shall be issued by a Bank located in the Republic of Kenya, or a foreign Bank through a correspondent Bank located in the Republic of Kenya, in either case subject to the approval of the Employer.

31 Corrupt or fraudulent practices

31.1 The procuring entity requires that tenderers observe the highest standard of ethics during the procurement process and execution of contracts. A tenderer shall sign a declaration that he has not and will not be involved in corrupt or fraudulent practices.

SECTION III:
APPENDIX TO INSTRUCTION TO BIDDERS

3.1 Appendix to Instructions to Tenderers

The following appendix to instructions to tenderers shall complement or amend the provisions of the instructions to tenderers (Section II). Wherever there is a conflict between the provisions of the instructions to tenderers and the provisions of the appendix, the provisions of the appendix herein shall prevail over those of the instructions to tenderers.

Table 3.1 Notes on the Appendix to Instructions to Tenderers

Clause	Description
2.1	<p>Pursuant to clause 2.1 the following shall be mandatory.</p> <ul style="list-style-type: none"> i) Properly filled, stamped and signed Form of Bid ii) Valid Bid Security and in the standard format provided in this tender document iii) Completed Confidential Business questionnaire iv) Copy of proof of citizenship of all the director(s) in the company. v) Certified Copy of current (within the last 12 months) Form CR12. vi) Certified copies of Certificate of incorporation/registration of business name or partnership deed vii) Valid tax compliance certificate as at the time of tender opening/closing viii) Copies of Current annual NCA practicing licence from National Construction Authority as a roads contractor for NCA Category 7 and above valid as at the date of tender closing/Opening ix) Written power of attorney authorizing the signatory of the bid to commit the bidder x) Attendance of Mandatory Organized Pre-Tender Site Visit and signing of attendance register & Submission of original dully signed, stamped and signed Certificate of site Visit xi) Information on Litigation and performance history as per schedule 10 xii) Completeness of tender(All required forms including the BOQs are properly filled as per clause 9.1 of ITT) xiii) All the pages of bid document to be serialized sequentially from cover page to the last page.
2.2	<p>Qualification Requirements</p> <ul style="list-style-type: none"> (a) Evidence of access to funds or financing agreement/lines of credit and availability of other financial resources. If a line of credit is provided the letter of line of credit must be current to the last one (1) month. (b) Financial predictions for the current year and the two subsequent years, including the effect of known commitments, (c) Current financial soundness and bidder's long-term profitability, Cash flow or equivalent positive working capital (d) Current Work commitments (e) Availability of critical equipment Major items of construction plant and equipment proposed for use in carrying out the Contract. (f) The qualifications and experience of key personnel proposed for administration

	<p>and execution of the contract, both on and off site.</p> <p>(g) Bidders shall also submit proposals of work execution programme in sufficient detail to demonstrate the adequacy of the bidders' proposals to meet the technical specifications and the completion time referred to in Schedule 11.</p> <p>(h) Details of experience and past performance of the tenderer on the works of a similar nature.</p> <p>(i) Details of Non-performance of contract and any current litigation or arbitration proceedings in which the tenderer is involved as one of the parties within the last Three (3) years prior to the dead line of the tender submission, based on all information on fully settled disputes or litigation.</p>
4.3	There will be MANDATORY organized site visit as indicated in the invitation to bidders, but the bidder may make further site visit on their own to the Park where he is bidding. Each tenderer must dully fill, and sign the attendance register and have his/her site visit certificate signed by the procuring entity representative who will be conducting the organised site visit
12.1	Tender validity period is 90 days from the specified date of tender opening or from the extended date of tender opening in accordance with ITT clause 7.3
13.2	The tender security shall be Kshs 500,000.00
13.3	Tender Security shall remain valid for a least 30 days beyond tender validity
26.5 and 27	The total budget for the road E682 is Kshs 40,881,086.26. The procurement Entity shall award to the lowest evaluated tenderer, whose tender is comparable at a margin of equal to or less than Employer's budget by 10% .The employer's budget was developed based on the G.o.K Cost Estimation Manual for Road Maintenance Works, First Revised Edition, July 2017.

	<p><u>Tender Format, No of sets, Sealing and Marking of Tenders</u></p> <p>The Tender shall be bound and divided clearly in descending order as listed below</p> <ol style="list-style-type: none"> 1. Letter of Invitation to Tender 2. Instruction to Tenders 3. Appendix to Instruction to bidders 4. Form of Bid 5. Appendix to Form of Bid 6. Bid Security 7. Schedule of Supplementary Information for Eligibility 8-A1 Confidential Business Questionnaire 8-A2 Certificate of Incorporation/Registration 8-A3 Copy of Form CR12 8-A4 Copy of Valid Tax Compliance Certificate 8-A5 Copy of Current annual NCA practicing licence for NCA Category 7 and above 8-B Form of Power of Attorney 8-C Certificate of site. 8-D Schedule of Major Items of Plant 8-E Schedule of Key Personnel and Signed CV 8-F Schedule of Road Works Completed Satisfactorily and Certified together with completion certificates or their proof of execution 8-G Schedule of ongoing Works 8-H A declaration that the bidder will not engage in any corrupt or fraudulent practice and 8-I A declaration that the person or his or her sub-contractors are not debarred from participating in procurement proceeding 9 Schedule of Supplementary Information on Financial standings 9-A Audited Financial Accounts. 9-B Construction Turnover. 9-C History of Non-Performance and Ligation History 10 Work Execution Programme. 11 Priced Bill of Quantities 12 Drawings 13 Specifications 14 Conditions of Contract.
17.1	
17.2	The format indicated above will be used for submission of this tender.
17.3	Original and one copy to be submitted, Sealing and Marking of tenders will be as per clause 17 of ITT <u>Copy must be replica of the original</u>
23.5	<u>Examination of and Determination of Responsiveness</u> Determination of a Tender's responsiveness will be based on the contents of the Tender itself without recourse to extrinsic evidence
	(a) Details of experience and past performance of the tenderer The contractor

	<p>must have:</p> <p>i. Successfully completed, as a prime contractor or management contractor, in the execution of at least three (3) contracts of a similar nature and comparable in complexity methods/technology or other characteristics to the proposed contract within the last Five (5) Years, each with a minimum value at least Kshs 15 Million (Kenya Shillings Fifteen Million Only) successfully and substantially completed</p> <p>ii. Average annual Construction Turnover of KShs.50 Million, calculated as total certified payments received for contracts in progress or completed, within the last Three [3] years in the role of contractor, subcontractor, or management contractor prior to the applications submission deadline.</p>
	<p>The minimum qualification of key personnel are as listed:</p> <p>(i) Ordinary Diploma in Civil Engineering with minimum Seven (7) years' experience in road works for Site Agent.</p> <p>(ii) Ordinary Diploma Engineering Survey or Equivalent with minimum Five (3) years' experience in road works for the surveyor and</p> <p>(iii) Ordinary Diploma Civil Engineering/Building and Construction with minimum 5 years' experience in road works for Foreman.</p>
	<p>(b) Equipment Capabilities: The bidder should list down, the major plants and equipment's as per schedule 4 of schedule of supplementary information. – Bidder must attach evidence of ownership, Lease agreement or any hiring arrangements. Bidders with proof of ownership of own equipment's will be awarded full marks, Leasing agreement will be awarded 75 % of full marks whereas proof of hiring will be awarded 50% of the full marks</p>
	<p>(c) Financial Soundness;</p> <p>i) The bidder should demonstrate that the firm has access to or has available, liquid assets, unencumbered real assets, lines of credit, and other financial means sufficient to meet the construction cash flow for a period of 2 months, estimated at 20% of the estimated tender sum.</p> <p>ii) Signed and stamped Audited accounts, balance sheets and computed working capital for the last three (3) years should be submitted and must demonstrate the soundness of the Applicant's financial position</p> <p>iii) The bidder's financial information will be assessed in terms of ROCE return on equity, Liquidity Ratios, current ratio and the point scale criteria on their financial position given on this basis</p>
	<p>(d) Bidders shall also submit proposals of work execution programmed in sufficient detail to demonstrate the adequacy of the bidders' proposals to meet the technical specifications and the completion time</p>
	<p>(e) The bidder must provide most current history of litigation and non-performance.</p>
	<p>(f) The pass mark for Technical Evaluation shall be 75%.</p>

3.2. SECTION III (B): TECHNICAL EVALUATION CRITERIA

This Section shall apply to tenderers whose bids have been determined to be responsive and have met all the Mandatory requirements based on the qualification Criteria as per the instruction to bidders. The information to be provided in relation to each factor and the definitions of the corresponding terms are included in the respective supplementary information Forms (Schedules). Table 3.2 summarises the post qualification score.

The Technical Evaluation Committee shall examine tender documents and score them based on their validity, accuracy and quality. Table 3-3 on the other hand illustrates how the marks will be tallied for each bidder based on their responsiveness to ITT. Where the bidder fails to meet the requirement, the bidder shall be disqualified.

Table 3.2: Post Qualification Score.

The information to be provided in relation to each factor in table 3.2 below and the definitions of the corresponding terms are included in the respective supplementary information Forms (Schedules).

Qualification Criteria			Submission Requirement	Compliance and Documentation	Score
Item	No	Subject			
Contractors Capability to supervise and perform the work	1	Equipment holding	<ul style="list-style-type: none"> - Proof of ownership of the required equipment. Attach copies of logbooks and TIMS account print out from NTSA Portal confirming ownership of the Equipment. - Current authorization letter of hiring from the Ministry of Transport & Infrastructure Housing and Urban Development & Public Works, Mechanical & Transport Services Department. - Or lease agreement from reputable hiring company(s) whose equipment details must be accompanied by copies of logbooks and TIMS account print out from NTSA Portal confirming ownership of the Equipment. <p><i>Bidders with proof of ownership of own equipment's will be awarded full marks, Leasing agreement will be awarded 75 % of full marks whereas proof of hiring will be awarded 50% of the full marks</i></p>	Clause 27.6 of ITT Section V, Schedule 4	20
	2	Key Personnel	Provide List of Key Site technical staff, their certified Qualification Certificates and resume. <ul style="list-style-type: none"> - General Experience (CV) - Certified copy of Qualification Certificate, 	Clause 27.5 of ITT Section V, Schedule 5	15
	3	Past relevant work Experience	<ul style="list-style-type: none"> - Completion certificate, Taking over Certificate or Substantial Completion Certificate of at least three (3) contracts of a similar nature and comparable in complexity, methods/technology and or other characteristics to the proposed contract in the last 5 years. Each of the three jobs above should be of minimum value of at least Kshs 15 Million. - Average annual Construction Turnover of KShs.50 Million, calculated as total certified payments received for contracts in progress or completed, within the last Three [3] years in the role of contractor - Value of ongoing work must be < 50% of Working Capital 	Clause 27.4 of ITT Section VII, Schedule 7 and 8	15

	4	Litigation history	- Record of litigation and non-performance in the previous 3 years.	Clause 26.11, of ITT Section V, Schedule 10 (4)	2
	5	Financial Capability	<p>The following information will be assessed from the documents provided by the bidders :</p> <p>i. Current financial soundness: <i>Submission of audited balance sheets or other financial statements for the last Three [3] years certified by practicing Auditor whose practicing number should be indicated.</i></p> <ul style="list-style-type: none"> - <i>Liquidity Ratios, Current Ratio and Return on Capital and Equity Ratio(ROCE)</i> <p>ii. Financial Proposal</p> <ul style="list-style-type: none"> - Evidence of access to financial resources to meet the qualification requirements equivalent to 20% of the tender sum: - <i>Authenticated bank statement from the issuing bank for the last 6 months with authority for verification from the bank providing the statements</i> - <i>Line of Credit or current bank balance in the last one month of tendering equivalent to 20% of the tender sum e.t.c</i> 	Clause 23.5 of ITT Section V, Schedule 10 (1 to 3)	18
Sub Total Score					70

Table 3.2 contractors capability to Supervise and Perform the Works Cont'					
Qualification Criteria			Submission Requirement	Compliance Requirement	Score
Item	No.	Subject			
Technical Proposal and comments	6	Mobilization Management plan	Bidder to submit the following Proposals in accordance with Clause 27.10 of ITT section VII i) Site lay plan out and Site Organization Chart ii) Mobilization and management plan for ✓ material ✓ Equipment ✓ Personnel	Section V, Schedule 11	6
	7	Quality and Quantity Management	Bidder to submit the following Proposals in accordance with Clause 26.1 of ITT section VII - Methodology work execution - Proposals on material testing - Proposal on measurements - Photograph plan	Section VII, Schedule 11	10
	8	Working Schedule and Projected Cash flow.	Bidder to submit the following Proposals in accordance with Clause 26.1 of ITT section VII 1. Signed work programme chart 2. Signed Cash flow plan during the contract period.	Section VII, Schedule 11	4
	9	Work safety management	Bidder to submit the following Proposals in accordance with Clause 26.1 of ITT section VII the following shall be provided; - Proposals on traffic control - workers safety & - accident prevention	Section VII, Schedule 11	5
	10	Environmental and social management	Bidder to submit the following Proposals in accordance with Clause 26.1 of ITT section VII - Proposal on environmental impact and social mitigation measures	Section VII, Schedule 11	5
Sub Total Score					30
GRANT TOTAL TECHNICAL SCORE					100

Bidders whose shall **score 75%** and above shall proceed to financial evaluation stage.

Table 3.3: Technical Score Sheet

Technical Evaluation of Tender No.....in National Park.									
Required References to be submitted in Tendering Forms from Tender for evaluation as indicated in section III (A)					Evaluated score for Each Bidder				
Item	Sub-Items		No Reqd	Distribut ed Score	Maxi Score	X	Y	Z	
Contractor's Capability to Execute Works	Equipment holding	Concrete Mixers and Vibrator	1	1	20				
		6 X 4 tippers payload 16 – 20 tones	4	4					
		Water tankers (18,000 – 20,000lts. capacity)	1	2					
		Wheeled loaders (2m3)	1	2					
		Motor graders (93 - 205kW)	2	5					
		Crawler Dozer (D6 and above) or Excavator	1	4					
		Self-propelled single drum vibrating (10 tons)	1	2					
	Key staff	Site Agent	Minimum Qualification Dip in Civil Eng.		1	15			
			Exp. 7Yrs and above		5				
			Signed CV		1				
		Forman	Minimum Dip in Civil Eng.		1				
			Exp.5Yrs and above		3				
			Signed CV		1				
	Surveyor	Minimum Dip. Cert in Survey and above		1					
		Exp.3Yrs and above		1					
		Signed CV		1					
	Past relevant work	Completion Certificate for at least three similar Works @ Kshs 15 Million	> 3no. Projects		10	15			
		Average annual Construction Turnover of KShs.50 Million.	Over last 5 years		5				
	History of litigation and non-performance.				2	2			
	Financial capability	Certified audited accounts for the last Three 3yrs	2013-2016 FY (3 Years)		5	18			
2013-2015 FY(2 Years)				2					
2015-2016FY (1Years)				1					
Current Financial Soundness ratios,		Proof of bidders access to financial resources e.g. Bank Statement current 6 months or current Line of credit within the last one month-(20% of tender sum)		8					
Mobilization management plan	Site lay plan out and material mobilization			1	6				
	Site Organization Chart			1					
	Equipment management plan			2					
	Personnel mobilization			2					
Quality and quantity management	Methodology statement			5	10				
	Proposals on material testing			2					
	Proposals on measurements			2					
	Photographic Plan			1					
Work scheduling	Work Programme charts			2	4				
	Cash flow plan			2					
Work safety management	Traffic control, and accident prevention			2	5				
	Workers safety			3					
Environmental and social management				5	5				
				Total Score	100				

3.4 Prequalification Checklist for Completeness and responsiveness

The bidder is provided with the following checklist to confirm if the bidders is complete and responsive.

Table 3.4: Prequalification Checklist for Completeness and responsiveness

S/No.	Completeness and responsiveness criteria	References	Required
1	Form of Bid	Section IV	Amount must be indicated, Properly filled, Stamped and signed. The tender sum should be valid for a period of ninety (90) calendar days from the specified date of tender opening
2	Bid Security	Section IV, ITT clause 12.	Unconditional guarantee, in the standard format provided in the tender document Must be valid for 120days
3	Eligibility	ITT clause 2.1	Provide all information requested,
4	Confidential Business Questionnaire	Section V, Schedule 1	Properly fill stamp and sign. and Provide all information requested., Conflict of Interest explicitly Stated Copy of National IDs or passports for all the directors and certified copy of Form CR12(Current within the last 12 months)
5	Tax Compliance Certificate	ITT clause 2.1	Copy provided must be Valid as at the date of Tender opening/closing
6	NCA practicing licence	ITT clause 2.1	Current annual NCA practicing licence for NCA Category 7 and above valid as at the date of Tender opening
7	Certificate of Incorporation	ITT clause 2.1	Copy of Certificate certified by the commissioner of oaths and valid as at the date of Tender opening
8	Form of Power of Attorney	Section V, Schedule 2	Properly fill sign and Stamp
9	Certificate of Tenderer site visit	Section V, Schedule 3	Attendance of pre-bid site visit, Signing of attendance register. In addition original site visit Certificate must be properly filled, stamped and signed by the bidder's representative and witnessed by procuring entity representative
10	Schedule of Major Items of Plant	Section V, Schedule 4	Fill properly in the format given stamp and sign. In addition attach proof of ownership in form of clear copy of Log book and/or TIMS account print out from NTSA Portal confirming ownership of the Equipment or any lease or hire agreement where applicable
11	Schedule of Key Personnel	Section V, Schedule 5	Properly fill and sign in the format given. Also attach signed CV and Certified copies of qualification Certificates as required
12	Declaration Form For Non – Corrupt Practices	Section V, Schedule 6	Fill properly in the format given stamp and sign
13	Declaration Form For Non	Section V,	Fill properly in the format given stamp and

	– Debarment by PPRA	Schedule 12	sign
14	Schedule of ongoing Works	Section V, Schedule 7	Fill properly in the format given and sign
15	Road Works Completed Satisfactorily	Section V, Schedule 8	Fill properly in the format given and sign and attach certified copies of completion certificates.
16	Basic Labour rates	Section V, Schedule 9	Fill properly in the format given and sign
17	Schedule of other supplementary, information /Financial standings	Section V, Schedule 10	Fill properly in the format given and sign
18	Litigation History	ITT clause 23.5	Fill properly in the format given and sign
19	History of Non-performance	ITT clause 27.12	Fill properly in the format given and sign
20	Work Execution Programme	Section V, Schedule 11 & Table 3.2, clause 23.5	Must be provided in the format given, brief and to the point
21	Priced Bill of Quantities	Section II, clause 11	Fill all rates, prices and amounts
22	Preparation and submission of the Tenders	Clause 9.1of the ITT	Submit a complete set of tender document as per the instruction to bidders Clause 9.1 and also ensure that all the forms BOQ and Schedules provided in the tender documents are properly filled for completeness
23	Copy of Bid Document	Section II, clause 17.3	An Original and a copy (a replica of the Original)

**SECTION IV:
FORM OF TENDER AND TENDER SECURITY**

FORM OF TENDER

{Name of Contract.....}:

The Director General,
Kenya Wildlife Service,
P.O Box 40241,
Nairobi

Dear Sir,

1. In accordance with the Conditions of Contract, Specifications, Drawings and Bills of Quantities/Schedule of Rates for the execution of the above named Works, we, the undersigned offer to construct, install and complete such Works and remedy any defects therein for the sum of Kshs.....[Amount in figures]

Kenya Shillings [Amount in words]

2. We undertake, if our tender is accepted, to commence the Works on the commencement date and to complete the whole of the Works comprised in the Contract within the time stated in the Appendix.

3. We agree to abide by this tender until[Insert date], and it shall remain binding upon us and may be accepted at any time before that date.

4. Unless and until a formal Agreement is prepared and executed this tender together with your written acceptance thereof, shall constitute a binding Contract between us.

5. We understand that you are not bound to accept the lowest or any tender you may receive.

Dated thisday of20.....

Signaturein the capacity of.....

Duly authorized to sign tenders for and on behalf of

.....[Name of Tenderer] of

.....[Address of Tenderer]

Witness:

Name.....

Address.....

Signature.....

Date.....

APPENDIX TO FORM OF TENDER

This Appendix to Form of Tender forms part of the Agreement. (Note: with the exception of the items for which the Employer's requirements have been inserted, the Contractor shall complete the following information before submitting his offer.)

CONDITIONS OF CONTRACT	CLAUSE	AMOUNT	
Bid Security	13.2	Kshs 500,000.00	
Amount of Performance Security (Unconditional Bank Guarantee)	4.4	5% per cent of Contract Price in the form of Unconditional Bank Guarantee	
Submission of Performance Security		Submitted by the 14 th day from the date of award letter	
Programme to be submitted	7.2	Not later than 14 (fourteen) days after issuance of Order to Commence	
Cash flow estimate to be submitted	7.2	Not later than 14 (fourteen) days after issuance of Order to Commence	
Minimum amount of Contractors All Risk Insurance Cover	14.1	0.3% of the Contract Price	
persons and damage to property Workers compensation		Contractor to indemnify employer against claims by those in employment of the contractor	
Submission of Contractors All Risk Insurance Cover		Submitted by the 14 th day from the date of award letter	
Currency of Payment	11.7	Kenya Shilling	
Period for commencement, from Engineer's order to commence	7.1	14 days	
Time for Completion	7.1	3 months	
Amount of liquidated damages	7.4	0.05 % of the contract price per day to a limit of 10% of contract sum.	
Limit of liquidated damages	7.4	10% of contract sum.	
Defects Liability period	9.1 and 11.5	14 days calculated from the date stated in the notice under sub clause 8.2	
Period of Contract Validity	14.1	From contract award up to the date of settlement of the agreed final statement issued pursuant to clause 60.6 rendering the contractor's clause 60.7 discharge to the employer effective.	
Percentage of Retention	11.4 and 11.5	5% of Interim Payment Certificate	
Limit of Retention Money	11.4	5% of Contract Price	
Minimum amount of interim certificates	11.2	10% of contract price	
Time within which payment to be made after Interim Payment Certificate signed by Engineer	11.3	28 (Twenty eight) days	
Appointer of Arbitrator	15.3	The Chartered Institute of Arbitrators - Kenya.	
Notice to Employer and Engineer		The Employer's address is: The Director General, Kenya Wildlife Service, P.O. Box 40241 - 00100 NAIROBI	The Engineer's address is: Head of Roads & Fleet Management -, Kenya Wildlife Service, P.O. Box 40241 - 00100 NAIROBI

FORM OF TENDER SECURITY

(Note: The tenderer shall complete only this form of bank guarantee. No other Form of Tender Bond or any other forms of security will be accepted. Tenderers who fail to comply with this requirement will be disqualified).

WHEREAS [Name of tenderer].

.....
.....

(Hereinafter called “the Tenderer”) has submitted his tender dated

For the

.....
.....

hereinafter called “the Bid”

KNOW ALL MEN by these presents that we [Name of Bank]

.....
.....

of (Name of Country) having our registered offices at

.....

(Hereinafter called the Bank) are bound unto **Kenya Wildlife Services**, (hereinafter called “the Procurement Entity”) in the sum of (in words) Kenya Shillings

.....

(In figures) Kshs).....

for which payment will be well and truly made to the said Procurement Entity the Bank binds itself, its successors and assigns by these presents.

Signed for the said Bank this day of , .20.....

THE CONDITIONS of this obligation are:

- a) If the tenderer withdraws his Tender during the period of tender validity specified by the bidder on the Tender Form; or
- b) If the Tenderer refuses to accept the correction of errors in his bid; or
- c) If the Tenderer having been notified of the acceptance of his tender by the Procurement Entity during the period of Tender Validity
 - (i) Fails or refuses to execute the Form of Agreement in accordance with the Instructions to bidder when required or
 - (ii) Fails or refuses to furnish the Performance Security, in accordance with the Instructions to bidder.

We undertake to pay to the Procurement Entity up to the above amount upon receipt of his first written demand, without the Procurement Entity having to substantiate his demand, provided that in his demand the Procurement Entity will note that the amount claimed by him is due to him owing to the occurrence of any of the above conditions, specifying the occurred condition or conditions.

This guarantee will remain in force up to and including thirty (30) days after the date of expiration of the tender validity, as stated in the Instructions to bidders.

At the request of the Procurement Entity the Tender validity period may be extended by mutual agreement between the Procurement Entity and the bidder and we undertake to extend the validity of this surety accordingly without you having to inform us of such an extension of the Tender validity period if within this period the bidder has been notified of the acceptance of his Bid. This Surety shall remain valid up to the time the Contract Agreement has been executed.

SIGNATURE AND SEAL OF THE BANK

.....

NAME OF THE SIGNATORY:

.....DATE..... ,

TITLE OF THE SIGNATORY

.....

NAME OF THE WITNESS:

.....

SIGNATURE OF WITNESS

.....DATE..... ,

ADDRESS OF THE WITNESS :

SECTION V:
SCHEDULES OF SUPPLEMENTARY INFORMATION

SCHEDULE 1: CONFIDENTIAL BUSINESS QUESTIONNAIRE

REPUBLIC OF KENYA

CONFIDENTIAL BUSINESS QUESTIONNAIRE

This Confidential Business Questionnaire of the Government of Kenya shall be completed by the Bidder or by each member of a Joint venture if the Bidder is a Joint-venture.

You are requested to give the particulars indicated in Part 1 and either Part 2 (a), 2(b) or 2(c) whichever applies to your type of business. You are also advised that it is a serious offence to give false information on this Form.

Part 1 - General:

Business Name:

Location of Business Premises

Plot No.*Street/Road*

Postal Address.....*Tel No.*

Email address

Nature of Business.....

Current Trade License No. *Expiring Date*

Maximum value of Business which you can handle at any one time:

Kshs.

Name of your Bankers.....

Branch.....

Part 2(a) - Sole Proprietor:

Your Name in full.....

Age:

*Nationality ***Country of Origin*.....

***Attach Copy of Citizenship (Compulsory).**

Part 2(b) - Partnership:

Give details of partners as follows:

Name	Nationality	Citizenship Details*	Shares
1.....	1.....	1.....	1.....
2.....	2.....	2.....	2.....
3.....	3.....	3.....	3.....

Note: Attach proof of citizenship of all partners (Compulsory) and Certified Copy of Form CR12 (Compulsory)

Part 2(c) – Registered Company

Give details of partners as follows:

Private or Public.....

State the Nominal and Issued Capital of the Company

Nominal Shares (Kshs)	Issued Shares (Kshs)
.....

Give details of all directors as follows:

Name	Nationality	Citizenship Details*	Shares
1.....
2.....
3.....
4.....
5.....

Note: Attach proof of citizenship of all directors (Compulsory) and Certified Copy of Form C12 (Compulsory).

Part 2 (d) Interest in the Firm:

Are there any person / persons in Kenya Wildlife Service who has interest in this firm? Mark in the box alongside as necessary.

Yes	No

If yes (specify)

.....

Date:..... Signature of Tenderer.....

SCHEDULE 2: FORM OF WRITTEN POWER OF ATTORNEY

The Bidder shall state here below the name(s) and address of his representative(s) who is/are authorized to receive on his behalf correspondence in connection with the Tender.

.....
(Name of Bidder's Representative in block letters)

.....
(Address of Bidder's Representative)

.....
(Signature of Bidder's Representative)

Alternate:

.....
(Name of Bidder's Representative in block letters)

.....
(Address of Bidder's Representative)

.....
(Signature of Bidder's Representative)

*To be filled by all Bidders.

Both representative and alternate must attach copy of National Identification card or Passport

1 SCHEDULE 3: CERTIFICATE OF SITE VISIT

1. This is to certify that

[Name/s].....

Being the authorized representative/Agent of [Name of Bidder]

.....

.....

has undertaken the inspection of site in accordance with the instruction to Bidders, for purposes of bidding for routine maintenance of

.....

.....

[name and location of the project] held on..... Day of.....20.....

2. Having studied the tender document, I carefully examined the site to make myself familiar with the local conditions likely to influence the works and cost thereof.

3. I further certify that I am satisfied with the description of the works and I understand perfectly the scope of the works as specified and implied in the performance of the contract

Signed and Stamped.....

(Bidder’s Representative)

Name

Signed

(Procuring Entity Representative during Site Visit)

NOTE: This form Must be completed and duly stamped & signed during the Organized site visit.

SCHEDULE 4: MAJOR ITEMS OF CONSTRUCTION PLANT AND EQUIPMENT

Item No.	Equipment Details	Minimum Number Required for the Contract Execution	No. of equipment to be made available for the Contract by the Bidder	Date of Arrival on Project (Days after commence)
(i)	Motor graders (93 - 205kW)	2		
(ii)	Hydraulic crawler mounted Dozer (D6 and above or excavator)	1		
(iii)	Wheeled loader (2m ³)	1		
(iv)	6 X 4 tippers payload 16 – 20 tones (5m ³)	4		
(v)	Self-propelled single drum vibrating (10 tons)	1		
(vi)	Water tankers (8,000 – 16,000 lts. capacity)	1		
(vii)	Mobile concrete mixers (0.3m ³) and vibrators	1		

The bidder shall enter in this schedule all major items of plant and equipment which he proposes to bring to site. Only reliable plant in good working order, and suitable for the work, shall be shown on this Schedule.

The bidder must attach proof of ownership or authorized letter of hire from reputable agencies. Refer to Table 3.2 for Submission requirements and Table 3.3 for award of scores on equipment holding.

I certify that the above information is correct.

Signature of Tenderer: Date:

Name of Signatory:

SCHEDULE 5: KEY PERSONNEL**i) Key Personnel proposed by Tenderer**

The Bidder shall list in this schedule the key professional and technical personnel he will employ, providing Proof of qualifications, experience, position held and nationality.

Name of Key Staff	Designation	Required (attach certified copies of qualification certificates)	
		Qualification	Ordinary Dip in Civil Engineering/Equivalent
	Site Agent	General Experience	At least 7 yrs
		Qualification	Ordinary Dip in Engineering Survey/Equivalent
	Surveyor	General Experience	At least 3 yrs
		Qualification	Ordinary Dip in Civil Engineering/Equivalent
	Foreman	General Experience	At least 5 yrs

I certify that the above information is correct.

Signature of Tenderer:Date:.....

Note

The CV's for each of the proposed key should be ***presented in the format*** indicated in the next page. ***Certified copies of the academic qualifications for each key staff must be attached.***

- a) **Format of Resume of Proposed Personnel** (use the same format for all other required staff)

Proposed Position				
Personnel information	<table border="1"> <tr> <td>Name of Personnel</td> <td>Date of birth</td> </tr> </table>	Name of Personnel	Date of birth	
	Name of Personnel	Date of birth		
	Professional qualifications			
<table border="1"> <tr> <td>Years of Experience</td> <td>Years with present employer</td> </tr> </table>	Years of Experience	Years with present employer		
Years of Experience	Years with present employer			
Present employment	Present Employer's Name:			
	<table border="1"> <tr> <td>Job Title</td> <td></td> </tr> </table>	Job Title		
	Job Title			
<table border="1"> <tr> <td>Name of Contact person (Supervisor)</td> <td>Telephone No</td> </tr> <tr> <td></td> <td>E-mail</td> </tr> </table>	Name of Contact person (Supervisor)	Telephone No		E-mail
Name of Contact person (Supervisor)	Telephone No			
	E-mail			
From	<p><i>(Summarize professional experience, in reverse chronological order. Indicate particular technical and managerial experience relevant to the project)</i></p> <p>Company / Project / Position / Role in project</p>			
To				

Signature of Proposed Staff.....Date:.....

Note: Please attach **Certified Copies of Qualification Certificates**

SCHEDULE 6: DECLARATION FORM FOR NON – CORRUPT PRACTICES

I/We of Post Office Box
..... declare that

I/ We recognize that Public Procurement is based on a free, fair and competitive tendering process which should not be open to abuse.

I/We

Declare that I/We will not offer or facilitate, directly or indirectly, any inducement or reward to any public officer, their relations or business associates, in connection with tender No.

..... for or in the subsequent performance of the contract if I/We am/are successful.

Signed by:

Director or Authorized Representative. Name

Designation.....

Signature.....

Date.....

SCHEDULE 7: SCHEDULE OF ONGOING PROJECTS

Bidders should provide information on their current commitments on all contracts that have been awarded, or for which a letter of intent or acceptance has been received, or for contracts approaching completion, or for which an unqualified, or full completion certificate has yet to be issued.

Name of Contract	Procurement Entity's contact address/fax	Value of Works (Kshs)	Date of commencement (M/YR)	Date of completion (M/YR)	Physically completed up to date %

NOTE: Provide the requested information as per the table above. Information presented in other format will be accepted (you may use an extra page of this format)

I certify that the above works are being carried out by me and that the above information is correct.

Signature of bidder:Date:

SCHEDULE 9: SCHEDULE OF LOCAL LABOUR BASIC RATES

The rates inserted in this schedule will be those used in determining changes in cost of local labour market.

LABOUR CATEGORY	MONTH/SHIFT/HOUR	UNIT	RATE (KShs)
Skilled Labour			
Semi-Skilled Labour			

NOTE: Categories to be generally in accordance with those used by the Kenya Building Construction Engineering and Allied Trade Workers Union and Ministry of labour

I certify that the above information is correct.

Signature of bidder: Date:.....

SCHEDULE 10: FINANCIAL CAPACITY/CURRENT COMMITMENTS

1. Financial reports for the last three (3) years, balance sheets, profit and loss statements, auditors' reports for the last three calendar years with certified English translation where appropriate. List them below and attach copies.

.....

2. Evidence of access to financial resources to meet the qualification requirements. Cash in hand, lines of credit etc. List below and attach copies of supporting documents (bank to fill attached form).

.....

- (a) Name/Address of Commercial Bank providing credit line

.....

Total amount of credit line Kshs.

(Attach a valid and current copy of the current Letter of Line of credit from the Bank.)

- (b) Attach certified copies of financial bank statements of the last six months.

3. Name, address, telephone, email address of the Tenders' Bankers who may provide reference if contacted by the Contracting Authority.

.....

4. Information on History of Non performing contract and current Litigation in which the Tenderer is involved.

- a) Provide Information on History of Non performing contract

OTHER PARTY (IES)	DETAILS OF NON PERFORMANCE	AMOUNT (KShs)	INVOLVED

- b) Provide Information on current Litigation involved.

OTHER PARTY (IES)	CAUSE OF DISPUTE	AMOUNT (KShs)	INVOLVED

All the requested information in spaces provided in the schedule 1-12 must be duly filled by the bidder.

I certify that the above information is correct

Signature of bidder:..... Date:.....

SCHEDULE 11: WORK EXECUTION PROGRAMME

Give a brief description of how you plan to carry out the works within the contract period. The Works execution programme should include all relevant information to the project. The information given should be clear, not flawed description and compliance to standard and special specification.

Note: Works Execution programme is different from form “programme of works referred in FIDIC and Standard Specification for Roads and Bridge Construction. The said “programme of works” is but part of Works Execution Programme (WEP).

The WEP will be used hand in hand with Supervision Check-list Manual indicated in Section –IX and the Supervision Check-list sheet in Appendix II below of the Tender Document for evaluation of the contractors’ performance and scoring during works execution. .

The Contents of Works Execution Programme shall include:

ii. General information

a) Project data

- Project name,
- employer,
- implementing agency
- contract period,
- date of completion,
- defects liability period,
- date of submission of works execution programme,

b) Scopes of works

A brief description of the project which includes major work items

iii. Mobilization Management Plan

- Site office Plan and site organization chart,
- Material mobilization plan
- Personnel management plan
- Equipment management plan

iv. Work execution schedule

- a) Signed Programme of works
- b) Signed cash flow plan during the contract period

It is desirable that work execution schedule includes time frame of each activity such as in bar chart format.

v. Quality and Quantity Management

- Method statement
This includes Work procedures, order and methods for execution.
- Proposal on material testing.
- Proposal on measurements
- Photograph plan

The bidder shall provide a photograph plan to record the progress and proof of quality control, measurement and any event that may arise

vi. Safety management plan

This includes but not limited compliance with safety rules and regulation, traffic control and detour plans, emergency contact list

vii. Environmental and social management plan

When the negative impacts on third parties during the execution are predicted, the management and mitigation plans should be included in WEP.

Note:

Works Execution Programme to be submitted by the bidder shall not be less 3 pages and not more than five (5) pages covering all the above stated items.

SCHEDULE 12: DECLARATION FORM (DEBARMENT)

Date.....

To

The Director General,
Kenya Wildlife Service,
P.O. Box 40241 - 00100
NAIROBI

We (name and address).....

Declare the following:

- a) Have not been debarred from participating in public procurement.
- b) Have not been involved in and will not be involved in corrupt and fraudulent practices regarding Public Procurement.

_____	_____	_____
Name of Bidder	Signature	Date
(To be signed by authorized representative and officially stamped)		

SECTION IV:
CONDITIONS OF CONTRACT

PART I: GENERAL CONDITIONS OF CONTRACT

The General Conditions of Contract of this contract are the FIDIC Short Form of Contract, First Edition, 1999, published by the International Federation of Consulting Engineers (FIDIC).

Notes

- i. The General Conditions of Contract must be retained intact to facilitate its reading and interpretation by tenderers is linked with the Conditions of Particular Application, referred to as Part II, by the consecutive numbering of the Clauses. Part I and II together comprise the conditions governing the rights and obligations of the parties.
- ii. In case of any inconsistency between the conditions contained in Part I and those in Part II, the conditions contained in Part II shall prevail over those of Part I.
- iii. The Tenderer is deemed to have read and fully complied with the General Conditions of Contract. A copy of General Conditions of Contract is available at the offices of the Employer's Representative for perusal.
- iv. Copies of the FIDIC Conditions of Contract can be obtained from:
FIDIC Secretariat
P.O. Box 86
1000 Lausanne 12

PART II: CONDITIONS OF PARTICULAR APPLICATION

The following Conditions of Particular Application amplify or modify the FIDIC Short Form of Contract in certain respects.

1 GENERAL PROVISIONS

1.1 Definitions

Add new Paragraph to sub-clause 1.1.8

1.1.8 (a) **“Week”** means a period of seven (7) consecutive days

1.1.8 (b) **“Month”** means calendar month

Add new paragraph to sub-clause 1.1.20 to 1.1.25

1.1.20 **“Appendix”** as referred to the General Conditions of Contract means Appendix to Form of Tender.

1.1.21 **“Labour and Equipment Based Methods”** means work methods in which most of the activities are carried out using labour and appropriate equipment is only used when it is more cost effective to execute the works.

1.1.22 **“Piece Work”** means the fixed quantity of work to be done by an individual worker to earn a fixed sum.

1.1.23 **“Task ”** means the amount of work to be done by one individual worker or a gang in order to earn one day’s wage.

1.1.24 **“Young Person”** means an individual male or female, who has attained the age of 16 years but has not attained the age of eighteen years.

1.1.25 **“2000 Strategy”** means an initiative by the Government of Kenya to improve the maintenance of the country’s Road Network by giving priority to maintenance through network approach, using appropriate technology, labour-based methods, local resources and increased usage of small-scale entrepreneurs.

1.2 Interpretation

Add sub-clause 1.2.1 as follows

1.2.1 Words having the same meaning

In the Contract Documents different words and expressions having the same meaning and value may be used. Such expressions are:

Bid	=	Tender
Priced Bill of Quantities	=	Schedule of Rates
Authorized person	=	Engineer

2 THE CONTRACTOR

2.1 General Obligations

2.1.1 Employment of Young Persons and Children

Contractor's attention is drawn to the Employment Act Chapter CAP 226 concerning the Employment of Young Persons and Children.

2.1.2 Conditions of Employment of Labour

The Contractor shall observe and fulfil the following conditions in respect of all persons employed by him in the execution of the Contract: -

- a) Where possible, employ labour on a daily task basis. The size of the daily task shall be what can reasonably be expected of a worker during a normal working day (8 hours).
- b) The Contractor shall pay wage rates and observe hours and conditions of employment of labour as established by Kenyan Laws and by agreement between Employers or other recognized authorities and trade unions for similar trades or industries in the District where this Contract work is to be carried out.
- c) The Contractor shall recognize the freedom of his employees to be members of trade unions. The Contractor's attention is drawn to the requirements of the Trade Unions Act (CAP 233). The Contractor should note that if at least 25% of his employees are members of a particular Trade Union Organisation, then he will be legally bound to recognise and negotiate with the organisation.

2.1.3 Reporting Requirements

The Contractor shall, if required by the Employer, submit a return in detail in such form and at intervals prescribed showing the staff and the number of several classes of labour employed by the Contractor.

2.1.4 Contract with Employees

(i) Working days

The Contractor shall recognize gazetted non-working days and allow in his programme of works for these days, which he/she is not, expected to work.

(ii) Safety and Health

- (a) The Contractor shall be responsible for the safety of all workers. In collaboration with, and to the requirements of the local health authorities, the contractor shall ensure that first aid equipment and stores are available on the Site at all times throughout the period of the Contract.
- (b) The Contractor shall be responsible for provision of potable water for the workers on site.

(c) In the event of any outbreak of illness of an epidemic nature the Contractor shall comply with and carry out such regulations, orders and requirements as may be made by the Government or the local medical or sanitary authorities for the purpose of dealing with and overcoming the same.

(iii) Contractor to Preserve Peace

The Contractor shall ensure that all his personnel on site comply with the Statutes, Ordinances, Laws, Regulations and By-Laws in force in Kenya and to prevent accidents or any riotous or unlawful behaviour by or amongst all those employed on or in connection with the works, and for the preservation of the peace.

2.1.5 Water for the Works

The supply of water shall be the responsibility of the Contractor.

2.1.6 Environment

The Contractor shall take all reasonable steps to protect the environment on the Site and avoid damage or nuisance to property. In particular, the Contractor shall carry out all activities in a manner that ensures:-

- a) Minimum erosion and sedimentation deposition on the drainage works;
- b) Maximum preservation of trees and shrubbery;
- c) No entrance or accidental spillage of solid matters, debris and other pollutants and waste into streams;
- d) Utmost safety of all activities on site.

2.2 Performance Security

Add the following at the end of this clause.

The performance security shall be valid until a date 14 days after the end of the period for notifying defects. The Employer shall return the security to the Contractor within 14 days of its expiration.

3 TIME FOR COMPLETION

3.1 Execution of the Works

Add new sub-clause to 7.1.1:

3.1.1 Progress Review Meetings

Regular progress review meetings between the Employer and the Contractor shall be held at least once a month. The Employer will decide the time for each of these meetings.

3.2 Programme

Add three new paragraphs under this Sub-Clause

7.2.1 On award the contractor with the assistance of the Civil Works superintendent shall prepare a Works Execution programme for approval by the Engineer. The programme shall take cognizance of the existing road condition, maintenance needs and the weather. The Engineer may adjust this programme to fit with the cash inflow from Kenya Roads Board.

3.2.1 Intended Construction Procedures, Order and methods

The Contractor shall show in the programme of works, the procedure, order and methods proposed in carrying out works with specific emphasis on the labour requirements, equipment utilisation and productivity.

3.2.3 Works Execution Programme Updating

Within the intervals stated in the Appendix, the contractor shall submit updated Works Execution Programme of the works.

4 CONTRACT PRICE AND PAYMENT

4.1 Valuation of the Works

Add the following sub-clauses:

4.1.1 Price Adjustment

This is a firm contract and no price adjustment will be allowed as a result of changes in cost and legislation

SECTION VII:

MINISTRY OF ROADS SUPERVISION CHECKLIST

The manual refers to Supervision Check List for road maintenance and evaluation of contractor's performance, 2011 November.

SECTION VIII:

MINISTRY OF ROAD MAINTENANCE MANNUAL, 2010

SECTION IX:

**SPECIFICATIONS FOR ROUTINE MAINTENANCE REHABILITATION AND SPOT
IMPROVEMENT WORKS**

Standard Specification

Where required, material to be incorporated in the works shall comply with the relevant section of the Standard Specification for Roads and Bridge Construction, 1986 Edition published by the Ministry of Transport and Communication.

Whenever reference is made to “The Engineer” in the specification, it shall be construed to be synonymous with the term “Employer” or “Employer’s duly authorised Representative” respectively as referred to in the Conditions of Contract.

SPECIAL SPECIFICATIONS**SECTION 1: GENERAL****LOCATION AND EXTENT OF SITE**

The Project is located in Tsavo East National Park and the total road length is 95 Km. which is an existing earth/Gravel road

102 EXTENT OF CONTRACT.

The extent of works under this particular contract entails:-

- General: Office administration and overheads/Preliminaries
- Site Clearance and spoil of unsuitable material
- Culverts and drainage works
- Passage of traffic
- Grading and gravelling works
- Any other works that may be instructed by the Engineer

104 PROGRAMME OF EXECUTION OF THE WORKS

The contractor shall provide the works programme, required under clause 14 of the Conditions of Contract, within 14 days of receipt of the Engineer's Order to commence work.

The programme shall be co-ordinated with climatic and other conditions to provide for the completion of the works in the order and by the time specified.

The Contractor shall carry out the contract in accordance with the programme agreed with the Engineer, but he shall in no manner be relieved by the Engineer's approval of the programme, of his obligation to complete the works in the prescribed order and by the prescribed completion date and he shall from time to time review his progress and make such amendments to his rate of execution of the works as may be necessary to fulfill his obligations.

105 ORDER OF EXECUTION OF WORKS

In addition to Clause 105 of the Standard Specification the Contractor shall carry out the Works such that a continuous and consecutive output of fully completed work is achieved. The Resident Engineer shall be required to check the contractor's work execution progress guided by the Supervision Checklist provided as **Appendix II** to these Special Specifications.

107 TAKING OVER CERTIFICATE

The minimum length of road for which a taking over or completion certificate will be issued shall be the whole road when completed.

109 NOTICE OF OPERATIONS**Add the following sub- Clause:***Notification Terms*

It shall be the Contractor's responsibility to notify the Engineer when any item of works scheduled are completed and ready for approval, and the contractor shall give sufficient notice to allow control test to be performed.

Explosives and Blasting

- (a) The requirements of the Laws of Kenya governing explosives and other requirements and regulations of Government of Kenya and other authorities shall be complied with.
- (b) No explosives of any kind shall be used without prior written consent of the Engineer.
- (c) The Contractor shall be solely responsible for the provision, handling, storage and transporting of all explosive ancillary materials and all other items of related kind whatsoever required for blasting.

117 HEALTH, SAFETY AND ACCIDENTS

Add to Sub-Clause 19.1 the following:

In addition to providing, equipping and maintaining adequate first aid stations with minimum of the following items:-Non Stick wound dressing, election of plaster/band aids, Crepe bandages,Gauze and cotton wool, Antiseptic solution (washing wounds), Oral re-hydration sachets,

Antiseptic cream – Betadine, Burnol, Pain killers Panadol, Disprin, Anti diarrhoea – Immodium, Diadis, Charcoal, Anti histamine – Piriton, Triludan, Anti nausea – Stemetil, Antibiotic – Amoxil, Seprin, Surgical gloves Eye ointment throughout the works in accordance with the Laws of Kenya, the contractor shall provide and should provide contact and written MOU with local dispensary or medical clinic during the duration of the Contract.

Such dispensary shall be with a qualified Clinical Officer / Nurse who shall offer the necessary medical advice on HIV and related diseases to the Engineer's and Contractor's Site staff.

The Contractor shall allow for this in the rates and be responsible for all site welfare arrangements at his own cost.

121 DIVERSION OF SERVICES

- (a) The Contractor shall acquaint himself with the location of all existing services such as telephone lines, electricity cables, water pipes, sewers etc., before execution of any works that may affect the services. The cost of determining the location of the existing services together with making good or repairing of any damage caused all to the satisfaction of the Engineer shall be included in the Bid rates.
- (b) Subject to the agreement with the Engineer, the Contractor shall be responsible for removal of alteration and relocation of existing services.
- (c) The Contractor shall indemnify the Employer against claims originating from damage to existing services or works.

123 LIAISON WITH GOVERNMENT AND POLICE OFFICIALS

The Contractor shall keep in close touch with the Police and the other Government officials of the area regarding their requirements in the control of traffic or other matters, and shall provide all assistance or facilities, which may be required by such officials in the execution of their duties.

124 LAND FOR ALL CAMPS SITES AND FOR THE CONTRACTOR'S OWN PURPOSES, INCLUDING TEMPORARY WORKS.

Notwithstanding Clause 124 of the Standard Specification all requirements of land for temporary works and construction purposes shall be to the approval of the Engineer but the Contractor will make all necessary arrangements with the property owners concerned and pay all charges arising there from. On or before completion of the Contract, the Contractor shall remove all temporary works and shall restore all such land to the condition in which it was immediately prior to the occupation thereof as far as is reasonable and practicable. No separate payment will be made to the Contractor on account of these items and the Contractor must make due allowance for them in his rates.

Notwithstanding Clause 120 of the Standard Specifications, the Contractor shall be required to appoint a competent surveyor who will liaise with the Engineer on matters related to the demarcation of the existing road reserve, site measurements, removal and reinstatement of existing services.

128 STORAGE OF MATERIALS

All materials shall be stored on Site in a manner approved by the Engineer and the Contractor shall carefully protect from the weather all work and materials which may be affected thereby.

129 TEST CERTIFICATES

When instructed by the Engineer the Contractor shall submit certificates of test from the suppliers of materials and goods required in connection with the works as the Engineer may require.

Such certificates shall certify that the materials or goods concerned have been tested in accordance with the requirements of the specifications and shall give the results of all the tests carried out. The Contractor shall provide adequate means of identifying the materials and goods delivered to the site with the corresponding certificates.

139 PRIME COST SUMS

The Contractor will be paid on a prime cost basis plus a percentage for overheads and profits under relevant items of the Bills of Quantities.

143 ENVIRONMENTAL PROTECTION

The Contractor shall ensure so far as is reasonably practicable and to the satisfaction of the Engineer; that the impact of the construction on the environment shall be kept to a minimum and that appropriate measures are taken to mitigate any adverse effects during the construction.

- (a) After extraction of materials, all borrows pits shall be backfilled to the satisfaction of the Engineer. In particular borrow pits near the project road shall be backfilled in such a way that no water collects in them.
- (b) Spilling of bitumen fuels Oils and other pollutants shall be cleared up.

SECTION 3: SETTING OUT & TOLERANCES**301 SETTING OUT**

- a) In addition to the provisions of clause 3.01(a) if the traverse points to be used for the setting out are close to the existing carriageway and interfere with construction works then the Contractor will have to relocate them to a location where they will not be disturbed. The co-ordinates and heights of all traverse points so located shall be listed and provided to the Engineer for checking and/or approval. Contractor shall also monument the new centreline every 200m along straight and all salient points along curves by a pin in the concrete beacon before commencement of any works.

The road reserve boundary posts shall have 12mm diameter steel pins embedded in concrete, 200mm long with 25mm exposed to the air, sticking out from its top surface. This pin shall be co-ordinated and heighten and result of the same shall be provided to the Engineer for approval. Cost of these works shall be included in the rates as no separate item has been provided.

Commencement of the works shall not be permitted until this basic survey data has been provided and approved by the Engineer for at least 5 Kms of the road

b) **Detailed Setting Out**

The reference peg shall be 50mm by 50mm in section, 600mm long and driven 400mm firmly into the ground and painted white above the ground. The offset from the centre line shall be indicated by small nail 20mm to 25mm long with its head flush with the top of the peg.

Chainages, offset and reference elevation shall be clearly indicated to the sides of the peg to the satisfaction of the Engineer.

After cutting of benches and prior to commencement of earthworks or subgrade works, Contractor shall take cross-sections again and submit the copy of the same to Engineer for agreement. These cross-sections shall then be used as basis of measurement for all subsequent layers, unless otherwise stated.

SECTION 4: SITE CLEARANCE AND TOP SOIL STRIPPING**401 SITE CLEARANCE**

Site Clearance shall be carried out as directed by the Engineer.

04 – 50 – 002: Grass Cutting (Manual)

Grass shall be defined as any form of plant growth including small shrubs having a girth of not more than 100mm measured at height of 150mm above ground level.

The grass shall be cut to height of not more than 50 mm above the ground. The width limits shall be as instructed by the Engineer. All cut grass shall be removed from the carriageway, side drains, mitre drains and inlets and outlet drains of structures/culverts and deposited in approved spoil dumps

Burning of the grass shall not be allowed and care shall be taken not to damage roadside fixtures such as signs and marker posts.

This activity shall be carried out twice, each time before the rainy season or as shall be instructed by the Engineer.

Work Method

The Contractor shall use labour to carry out this item of work.

Quality Control

The road width for grass cutting shall be measured using tape measure at 50-m intervals and shall be visually checked to be free of grass after the operation.

Measurement: m²

The unit of measurement shall be square metres of grass cut.

Payment

The unit rate shall be full compensation, for labour, materials, tools, equipment and any incidental costs required to carry out the prescribed works.

04 – 50 – 003: Bush Clearing

This activity involves removal of small trees, shrubs and bushes all including their root system so as to prevent re-growth. In addition, the Engineer may order the trimming of branches of large trees so as to improve visibility. The width limits shall be as instructed by the Engineer.

The cut down material shall be collected into heaps away from the side drains and where it shall not block or interfere with visibility problems.

Burning of cut bush and removed trees or branches shall not be allowed.

Work Method

The contractor shall use **Labour** to carry out this item work

Quality Control

The width for bush clearing shall be measured using a tape at 50-m intervals and shall be visually confirmed to be free of trees or bushes.

Measurement : _____ m²

The unit of measurement shall be the area in square metres.

Payment

The unit rate shall be the full compensation, for labour, materials, tools, and any incidental costs required to carry out the prescribed works.

402 REMOVAL OF TOPSOIL

Topsoil shall include removal of up to 200mm depth of any unsuitable material as directed by the Engineer.

403 REMOVAL OF STRUCTURES, FENCES AND OBSTRUCTIONS

When instructed by the Engineer, the Contractor shall demolish or remove structure and payment for this shall be made on day works basis.

04 – 50 – 008: Clearing of Obstructions

This activity shall involve to the following tasks:-

- Inspection of the road section(s) included in the contract daily.
- Removal of all obstruction such as fallen trees/ branches, rock fall, landslides, broken signs, etc. away from the roadway road side drains, mitre drains and other drains, inlets and outlets of drifts, culverts and other structures and the safe disposal thereof outside the road formation width.
- Removal of dead animals' carcasses away from the carriageway and disposing them as directed by the Engineer. Liaison with the Police may be necessary.

Work Method

The contractor shall use **labour** to carry out this item of work

Quality Control

The road section shall be visually checked for any obstruction.

Measurement

The unit of measurement for this item shall be **lump sum per Km** for the contract period.

Payment

The unit rate shall be the full compensation for the provision of labour, and tools necessary to carry out the tasks listed above.

SECTION 5: EARTHWORKS

504 PREPARATION PRIOR TO FORMING EMBANKMENT

Where benching is required for existing pavement to accommodate earthworks subgrade or subbase for widening the road, the rate for compaction of existing ground shall be deemed to cover this activity.

Excavation in the pavement of the existing road shall be kept dry. In the event of water penetrating the underlying layer, construction of the subsequent layers shall be postponed until the underlying layers are dry enough to accommodate the construction plant without deforming or otherwise showing distress.

Step construction shall be carried out per layer at the joint where excavating both vertically and perpendicular to the direction of the travel. The step shall be 500mm perpendicular to the direction of the travel and 150mm vertical unless otherwise instructed by the Engineer.

Special care shall be taken when compacting the new material at the joint ensuring that specified density is achieved.

505 CONSTRUCTION OF EMBANKMENTS

Only material approved by the Engineer shall be used for fill in embankments. Material with high swelling characteristics or high organic matter content and any other undesirable material shall not be used, unless specifically directed by the Engineer. Unsuitable material shall include:

- (i) All material containing more than 5% by weight or organic matter (such as topsoil, material from swamps, mud, logs, stumps and other perishable material)
- (ii) All material with a swell of more than 3% (such as black cotton soil)
- (iii) All clay of plasticity index exceeding 50.
- (iv) All material having moisture content greater than 105% of optimum moisture content (Standard Compaction)

Subgrade: Shall mean upper 300mm of earthworks either insitu or in fill and subgrade shall be provided for as part of earthworks operation and payment shall be made as “fill”. The material for subgrade shall have a CBR of not less than 8% measured after a 4-day soak in a laboratory mix compacted to a dry density of 100% MDD (AASHTO T99) and a swell of less than 1%.

Subgrade repair: Where directed by the Engineer, any localized failure in the subgrade shall be repaired by filling in selected soft, hard or natural of minimum CBR 30% and compacted in accordance with clauses in the specifications applying to normal subgrade.

Embankment repair: Where directed by the Engineer, any localized filling in soft, hard or natural; selected material requirements shall be executed with Clause 505.

508 COMPACTION OF EARTHWORKS

At pipe culverts, all fill above ground level around the culverts shall be compacted to density of 100% MDD (AASHTO T.99) up to the level of the top of the pipes or top of the surround(s), if any and for a width equal to the internal diameter of the pipe on either side of the pipe(s) or surround(s) as applicable.

At locations adjacent to structures, all fill above ground level up to the underside of the subgrade shall be compacted to density of 105% MDD (AASHTO T.99). In case of fill around box culverts this should be

carried out for the full width of the fill and for a length bounded by the vertical plane passing through the ends of the wingwalls.

Notwithstanding the provision of clause 503 of the standard Specification, Compaction of subgrade material (i.e. material immediately below formation) in cut areas shall not be carried out by the contractor in areas where the formation is formed in hard material, unless the Engineer issues specific instructions to the contrary are issued.

Where improved sub-grade material shall be required, this shall be compacted and finished to the same standards and tolerances as those required for normal subgrade and clauses in the specifications applying to normal subgrade shall also apply.

511 **BORROW PITS**

The first part of the Standard Specification is amended as follows: -

Fill material which is required in addition to that provided by excavation shall be obtained from borrow pits to be located and provided by the Contractor but to the approval of the Engineer contrary to what has been stated.

05 – 70 - 001: **Grassing (Repair of erosion on shoulders / planting of grass)**

This activity shall involve protection / repair of erosion on embankment slopes, cut faces, shoulders, side slopes by filling with suitable soils and compacting using appropriate tamping tools as instructed by the Engineer.

Contractor shall plant turf of approved indigenous ‘runner’ type grass. The Contractor shall care for and water the grass until it is firmly established.

Work Method

The contractor shall use **Labour or equipment** carry out this item work.

Quality Control

- The width of the slope shall be measured at 50m intervals and shall have maximum tolerances of + / - 100mm.
- The quality of grass and spacing of the sprigs shall be visually checked

Measurement: _____ m²

The unit of measurement shall be total area in square metre calculated as the net area, measured on the slope.

Payment

The unit rate shall be full compensation, for labour, materials, tools, and any incidental costs required to carry out the prescribed works

517 **MEASUREMENT AND PAYMENT**

Notwithstanding the provisions of clause 517 of the standard specifications, the rate for compaction of fill in soft material shall allow for the requirements of clause 508 of the special specification and no extra payment shall be made for compaction around pipe culverts (100% MDD AASHTO T.99).

SECTION 6: QUARRIES, BORROW PITS, STOCKPILES AND SPOIL AREAS**601 GENERAL**

Notwithstanding any indications to the contrary in the Standard specification the Engineer will not make available to the Contractor any land for quarries, borrow pits, stockpiles and spoil areas, except for those areas in road reserves specifically approved by him.

The contractor will be entirely responsible for locating suitable sources of materials complying with the Standard and Special Specifications, and for the procurement, Wining, haulage to site of these materials and all costs involved therein. Similarly the contractor will be responsible for the provision and costs involved in providing suitable areas for stockpiling materials and spoil dumps. Should there be suitable sites for spoil dumps or stockpiles within the road reserve forming the site of the works the Contractor may utilise these subject to the approval of the Engineer.

No additional payment will be made to the Contractor to cover costs arising from the requirements for this Clause and the Contractor must include these costs in the rates inserted into the Bills of Quantities.

SECTION 7: EXCAVATION AND FILLING FOR STRUCTURES**703 EXCAVATION OF FOUNDATIONS FOR STRUCTURES**

Unless otherwise instructed by the Engineer, all excavated surfaces in material other than hard material, on which foundations for structures shall be placed, shall be compacted to 100% MDD (AASHTO T.99) immediately before structures are constructed.

Paragraph 4, last line: - Replace "95%" with "100%".

707 BACKFILLING FOR STRUCTURES

Unless otherwise instructed by the Engineer, all backfilling material shall be compacted to a minimum of 100% MDD (AASHTO T.99).

709 EXCAVATION FOR RIVER TRAINING AND NEW WATER COURSES

Payments for river training and establishment of new watercourses shall only be made where such work constitute permanent works. Works done for road deviation or other temporary works shall not qualify for payment.

710 STONE PITCHING

Stone pitching to drains, inlets and outlets of culverts to embankments and around structure shall consist of sound unweathered rock approved by the Engineer.

The stone as dressed shall be roughly cubical in shape with minimum dimensions of 150 x 150mm for normal thickness of stone pitching.

The surface to receive the pitching shall be compacted and trimmed to slope and the stone laid, interlocked and rammed into the material to give an even finished surface.

In areas where stone pitching has been damaged, the Contractor shall identify such areas and notify the Engineer for his agreement of the extent of the Works required and his approval and instructions to proceed with the Works. Stone Pitching Repair and Reconstruction shall be carried out in accordance with Clause 710 of the Standard Specifications.

The Works shall involve, removal of the damaged stone pitching and reconstruction of the said areas in accordance with Clause 710 of the Standard Specifications by use of the sound salvaged material together with any necessary additional material where all such materials shall comply with Section 7 of the Standard Specifications.

Contrary to Clause 713 of the standard specifications, the rates inserted for stone pitching shall allow for grouting.

711 GABIONS

Where instructed by the Engineer the Contractor shall install gabions as protection works to washout areas or bridge Piers and or Abutments. Gabions shall be constructed in accordance with Clause 711 of the Standard Specification.

In cases where existing gabions have been damaged, the Contractor shall identify them and notify the Engineer for his agreement of the extent of the Work required and his approval and instructions to proceed with the Works.

The Works shall involve removal of the damaged gabions / rocks, excavation to the correct levels and grades as directed by the Engineer, and in accordance with Clause 711 of the Standard Specifications and reconstruction with new gabions and other necessary materials as necessary. The damaged gabions shall be recovered and transported to the nearest D.W.O's Yard or M.O. R.& P. depot.

712 RIP-RAP PROTECTION WORK

Quarry waste or similar approved material shall be used to backfill scoured and eroded side, outfall and cut-off drain. The material shall be compacted to form a flat or curved surface preparatory to stone [pitching of drainage channels, existing and new scour checks as directed by the Engineer.

The surface to receive the pitching shall be compacted and trimmed to slope and the stone hand laid, interlocked and rammed into the material to give an even finished surface. The interstices of the Pitching shall be rammed with insitu material. The insitu material immediately behind the pitching shall be compacted to minimum density of 100% MDD compaction (AASHTO T.99).

714 BACKFILL BELOW STRUCTURES

Where instructed this shall be carried out in compliance with the requirements of Clause 507 and 804 of the Standard Specification.

SECTION 8 - CULVERTS AND DRAINAGE WORKS

801 SCOPE OF SECTION

The operations specified in this section apply to the installation of drainage works and reinstatement and improvement of the same.

In addition, this Section covers: -

- Installation of 450 mm, 600 mm, 900mm or 1200mm diameter pipe culverts
- Desilting and cleaning of existing pipes and outfall drains to make them free flowing.

This activity consists of supplying the concrete pipe rings, laying and joining the rings, excavating and backfilling the trench and constructing a ramp over the culvert.

804 EXCAVATION FOR CULVERTS AND DRAINAGE WORKS

This Item consists of excavating trenches for culverts, foundations for head and wing walls and the construction of pipe culverts. The dimension of excavation shall be specified in the Drawings or shall be as directed by the Engineer. The Engineer shall approve all excavation work before the contractor is allowed to proceed with other works.

In the Standard Specifications, make the following amendments: -

In paragraph 6, line 3, and in paragraph 7, line 5 and in paragraph 11, line 6, delete "95%" and insert "100%".

Removal of Existing Pipe Culverts

Where instructed by the Engineer, the Contractor shall excavate and remove all existing blocked or collapsed culvert pipes of 450 mm, 600 mm and 900mm diameter including concrete surround, bedding, inlet and outlet structure and cut to spoil.

The void left after removal of culvert pipes shall be widened as necessary to accommodate new concrete bedding, pipe and hunching.

The payment of this work shall be per linear metre of pipes removed, and the volume in m3 of inlet/outlet structure removed. The void left by removal of these pipes shall be carefully preserved in order to accommodate replacement with 450 mm, 600 mm or 900 mm diameter pipe culverts as shall be directed by the Engineer.

Removal of Other Existing Drainage Structures

When instructed by the Engineer, the Contractor shall demolish or remove any other structure and payment shall be made on day work basis.

Excavation for Culverts and Drainage Works

The Contractor shall carry out all excavations for new culverts and drainage works to the lines, levels, inclinations, and dimensions shown on the drawings or as instructed by the Engineer.

805 EXCAVATION IN HARD MATERIAL

In the Standard Specifications, Sub-clauses 805(a) and 805 (b) delete "95%" and insert "100%".

In sub-clause 809(a), paragraph 1, line 1, substitute "95%" with "100%".

In sub-clause 809(c), paragraph 2, line 4, between the words "compacted" and "and shaped" insert the words "to 100% MDD (AASHTO T.99)".

Hard material is material which can be excavated only after blasting with explosives or barring and wedging or the use of a mechanical breaker fitted with a rock point in good condition and operated correctly. Boulders of more than 0.2m³ occurring in soft material shall be classified as hard material.

809 BEDDING AND LAYING OF PIPE CULVERTS

Concrete pipes shall be laid on a 150mm thick concrete bed of class 15/40 and the pipes shall be bedded on a 1:3 cement-sand mortar at least 50mm thick, 150mm wide and extending the full length of the barrel.

Pipe culverts shall be haunched using 150mm concrete Class 15/20 surround as per profile IV as indicated in the drawings. Headwalls/Wing walls, toe walls and aprons shall be constructed with class 20/20 concrete.

Backfilling shall be done with approved material and compacted layers not exceeding 150 mm loose. Ramps shall be shaped to achieve a minimum overfill of 3/4 of the pipe diameter.

The rates inserted shall allow for compaction of the bottom of excavation to 100% MDD (AASHTO T.99).

810 JOINTING CONCRETE PIPES

The pipe rings shall be of Class 20 concrete, at least 28 days cured and, manufactured on site or procured from a supplier approved by the Engineer.

The concrete pipes for the culverts shall have ogee joints and will be jointed by 1:2 cement: sand mortar and provided with fillets on the outside as described in clause 810 of the Standard Specification. The culvert gradient including the outlet shall be minimum 2%.

812 BACKFILLING OVER PIPE CULVERTS

In the Standard Specifications, clause 812

- a) *Delete paragraph 6 " for pipe culvertsdepth of 150mm", entirely.*
- b) *Wherever the expression "dry density of 95% MDD (AASHTO T. 99)" appears delete and replace with "dry density of 100% MDD (AASHTO T.99)".*

*The rates entered for laying of pipe culverts shall allow for backfilling to pipe culverts and compacting to 100% MDD (AASHTO T.99) and these works shall be deemed included in the contractors rate and shall **not** be measured and paid for separately.*

Quality Control

- The dimensions of the trench shall be checked using tape measure and shall have a tolerance of + / - 50mm
- The invert level shall be checked using line and level and shall have a tolerance of + / - 50mm
- The trench bottom shall be checked using straight edge, spirit level and shall have a tolerance of + / - 10mm
- Culvert quality shall be checked visually for cracks, honey combing etc
- The length of each pipe shall be checked using tape measure and shall have a tolerance of + / - 10mm.
- Before the pipes are laid, the gradient of the culvert trench shall be checked using boning rods and line levels and shall have a tolerance of + / - 1%
- The joint shall be visually checked to have been properly made

Measurement: m

The unit of measurement shall be in linear metres of installed size of culvert specified

814 SUBSOIL DRAINS

In the event of excavation for repairs exposing local see page, springs or unacceptably high water table, the Engineer may instruct the provision of counter fort or French drains.

These drains shall consist of a trench excavated to the alignment, width, depth and gradient instructed by the Engineer, and backfilled with approved compacted clean hard crushed rock material as specified in clause 815 of the standard specification. Where these drains lie within the carriageway the carriageway shall be reinstated with compacted graded crushed stone or stabilised gravel and surfaced with hot asphalt or a surface dressing as instructed by the Engineer.

Payment will be paid in accordance with Clause 814 of the Standard Specification.

817 REPAIRS TO DRAINS**08 – 70 – 001/2: Provide material to reconstruct or repair headwall, and wing wall****i). Stones, ii) Concrete blocks**

This activity shall include provision of all materials required and to carry out repairs to damaged head walls and wing walls as shown in the drawings and as instructed by the Engineer.

Work Method

The contractor shall use **Labour** to carry out this item of work

Quality Control

- The dimension of the headwalls shall be checked with tape measure and shall have maximum tolerances of + / - 50mm
- The levels shall be checked with line levels, straight edge and spirit levels and shall have maximum tolerance of + / - 20mm

Measurement m²

The unit of measurement shall be square metres for masonry paid for on the basis of area of wall completed while the concrete works shall be cubic meters paid for on the basis of volume of concrete poured in the wall.

Payment

The unit rate shall be full compensation for labour, materials equipment, tools, material haulage and unloading as required to carry out the prescribed works

08 – 70.003: Provide material to reconstruct headwall, wing wall**i) Stones, ii). Concrete blocks**

This item consists of provision of material and construction of masonry walls as detailed in the drawings..

Work Method

The contractor shall use both **labour** and equipment to carry out this item work

Quality Control

- The dimensions of the structure shall be checked using tape measure and shall have a tolerance of + / - 10mm
- The levels shall be checked using line and level, straight edge and spirit level and shall have a tolerance of + / - 10mm
- The quality of the mortar joints shall be checked visually

Measurement _____ m²

The unit of measurement shall be the total area in square metres of wall constructed.

Payment

The unit rate shall be the full compensation for labour, material, equipment and any other incidentals that may be required in carrying out the work as prescribed.

08 – 70.004 : Provide material and construct headwall, wing wall and apron – Concrete

This work consists of provision of all materials, and construction of the structures as detailed in the drawings. Aprons shall be constructed using concrete. Concrete shall be class 20/20 unless otherwise specified.

Work Method

The contractor shall use both **labour** and equipment to carry out this item work

Quality Control

- The dimensions of the structure shall be checked using tape measure and shall have a maximum tolerance of + 20mm / - 10mm
- The workability and mix of concrete shall be checked using the slump test and shall have a maximum tolerance of + / - 25mm of slump. The frequency of testing shall be determined by the Engineer
- The concrete shall be visually checked for any cracks or honey combing

Measurement _____ m³

The unit of measurement shall be the total volume in cubic metres of concrete.

Payment

The unit rate shall be the full compensation for labour, material, equipment and any other incidentals that may be required in carrying out the work as prescribed.

08 – 70.005-010: Provide and install or repair scour checks

i) –Stone; ii). - Wooden stakes; iii) - Concrete

Scour checks shall be constructed or repaired using either stones or sticks, as instructed by the Engineer.

Construction of concrete scour checks shall be in class 20/20 concrete unless otherwise specified and as per the details shown in the drawings.

Spacing for scour checks depends on the gradient of the drain as given in the guidelines shown in Table 8.1

Table 8.1 : Scour checks spacing

Gradient of Drain	Scour Check Spacing	Gradient of Drain	Scour Check Spacing
4% or less	not required	8%	7.5m
5%	20m	9%	6m
6%	15m	10%	5m
7%	10m	>10%	4m

Work method

The contractor shall use **labour** to carry out this item work.

Quality Control

The spacing of the scour checks shall be checked using tape measure and shall have a tolerance of + / - 0.5m
The sizes of the stakes and stones used shall be visually checked.

The shape of the scour check shall be checked using the scour check template.

Measurement: **No.**

The unit rate of measurement shall be the **number** of scour checks constructed.

Payment

The unit rate shall be full compensation, for labour, materials, equipment, haulage and any incidental costs required for carrying out the prescribed works.

817.1 Cleaning Existing Drains

In areas of existing side drains, mitre or outfall drains where such are blocked, the Engineer shall instruct the Contractor to clean and clear the drains to free flowing condition. The work shall consist of:

- (a) Stripping and removal of any extraneous material to spoil including vegetation and roots in the drains to the satisfaction of the engineer.
- (b) Spreading of any spoil to the satisfaction of the Engineer.
- (c) Shaping the drains to free flowing condition.
- (d) Removing any obstruction materials in the drains.

Cleaning any closed structures including cross culverts of any size to free flowing conditions.

Measurement and Payment for cleaning drains shall be by cubic metre of drain cleaned measured as the product of plan area and vertical depth of extraneous material instructed to be removed. No extra payment will be made for removal of vegetation and roots.

08 – 50 – 002: Cleaning of the Side Drains / Catch water drains

Partially silted

Partially silted drain shall be that drain that is less than half silted and requires only cleaning.

All deposited material, debris, and vegetation shall be removed and the drain shaped to the original cross-sectional standard and shall be in a free-draining condition. All debris and other unsuitable material removed from the side drains shall be disposed well clear of the drainage system in approved spoil dumps where it cannot cause any obstruction or be washed back.

The side drains shall be cleaned before the onset of the rains. The Engineer may instruct the contractor to clean the side drains immediately after heavy downpours.

Work Method

The contractor shall use **labour and or equipment** to carry out this item work

Quality Control

- Appropriate drain templates shall be used to check and control the dimension of the drains.
- The longitudinal profile of the drains shall be checked using boning rods, string and line-level.

Payment

The unit rate shall be full compensation, for labour, tools, and any incidental costs required to carry out the prescribed works

08 – 50 – 002: Desisting / Reshaping of the Side Drains / Catch water Drains

Fully silted

Fully silted Catch water or side drain shall be that drain that is greater than half-silted and requires re excavation or reshaping

All deposited material, debris, and vegetation shall be removed and the drain shaped to the original cross-sectional standard and shall be in a free-draining condition. All debris and other unsuitable material removed from the side drains shall be disposed well clear of the drainage system in approved spoil dumps where it cannot cause any obstruction or be washed back.

The side drains shall be desilted or re-excavated before the onset of the rains and during grading

Work Method

The contractor shall use **Equipment and or Labour** as directed to carry out this item work. Reshaping of the side drain shall be done together with the carriage way.

Quality Control

- Appropriate drain templates shall be used to check and control the dimension of the drains.
- The longitudinal profile of the drains shall be checked using boning rods, string and line-level.

Measurement for works on catch water drain: m³

Under this item the unit of measurement shall be the total volume in cubic metres of excavated material, excavated in its original position.

Measurement for works on side drain:

Under this item measurement shall be considered in the grading works except when the work is order by the Engineer where no grading or gravelling is required on the pavement. In such case the unit of measurement shall be the total volume in cubic metres (m³) of excavated material, excavated in its original position.

Payment

The unit rate shall be full compensation, for labour, tools, and any incidental costs required to carry out the prescribed works

08 – 50 – 005: Cleaning of Mitre drains

Partially silted

Partially silted drain shall be that drain that is less than half silted and requires only cleaning

All silt, debris, and vegetation shall be removed and the drain shaped to the instructed cross-section and be in a free-draining condition. All debris and other material removed from the mitre drains shall be disposed away and clear of the drainage system in approved spoil dumps to prevent debris from being washed back.

The mitre drains shall be cleaned before the onset of the rains.

Work Method

The contractor shall use **Equipment and or Labour** as directed to carry out this item work.

Quality Control

- Appropriate drain templates shall be used to check and control the dimension of the drains.
- The longitudinal profile of the drains shall be checked using boning rods, string and line-level.

Measurement: m

Under this item the unit of measurement shall be the total length in linear metres of the drain cleaned

Payment

The unit rate shall be full compensation, for labour, tools, and any incidental costs required to carry out the prescribed works.

Fully silted

Fully silted drain shall be that drain that is greater than half-silted and requires re excavation or reshaping.

All silt, debris, and vegetation shall be removed and the drain shaped to the instructed cross-section and be in a free-draining condition. All debris and other material removed from the mitre drains shall be disposed away and clear of the drainage system to prevent debris from being washed back.

The mitre drains shall be cleaned before the onset of the rains.

Work Method

The contractor shall use **Equipment and or Labour** as directed to carry out this item work

Quality Control

- Appropriate drain templates shall be used to check and control the dimension of the drains.
- The longitudinal profile of the drains shall be checked using boning rods, string and line-level.
- Siltation/Obstructions must be less than 50mm in depth
- The longitudinal profiles mitre drains shall be checked using boning rods and shall have tolerances of +/- 25mm;
- The dimensions of the mitre drains shall be checked using template and tape measure and shall have tolerances of +20mm or -10mm;

The location of the mitre drains shall be checked visually

Measurement: _____ m³

Under this item the unit of measurement shall be the total volume in cubic metres of excavated material, excavated in its original position.

Payment

The unit rate shall be full compensation, for labour, tools, and any incidental costs required to carry out the prescribed works.

817.2 Channels

817.3 RUBBLE FILLS FOR PROTECTION WORK

Quarry waste or similar approved material shall be used to back fill scoured and eroded side, outfall and cu-off drains. The material shall be compacted to form a flat or curved surface preparatory to stone pitching of drainage channels, existing and new scour checks as directed by the Engineer.

817.4 Stone Pitching

Stone pitching shall be constructed in accordance with clause 710 of the standard Specification.

Gabions

Gabions shall be constructed in accordance with clause 711 of the standard Specification.

Spoil Material

The Contractor shall be responsible for removal from site of all materials excavated in the course of undertaking works in this section of the specifications, unless suitable for re-use, and deposit of the material in a spoil dump to be approved by the Engineer.

SCOUR CHECKS

Scour checks are to be constructed in mass concrete in accordance with clause 818 of the standard specifications and the drawings as shall be provided.

05 – 007: Catch water drains

The cross section details shall be provided in the drawings or shall be as directed by the Engineer. In steep gradient scour checks may be installed in the catch water drains and grass cover shall be encouraged to grow in the drain. The excavated material shall be deposited at the lower (valley) side of the drain.

The location of the drains shall be checked and approved by the Engineer before construction;

The cross section dimensions shall be checked using tape measure at 25 m intervals and tolerances shall be +/- 25mm

Work Method

The contractor shall use **Labour or Equipment to** carry out this item work.

Measurement: _____ m³

The unit of measurement shall be cubic metres of materials excavated.

Payment

The unit rate shall be full compensation for labour and any incidental costs required for carrying out the prescribed works

819 CLEANING AND MAINTENANCE

819.1 De-silting of Pipe Culverts

Where Contractor instructed shall desilt the existing pipe culverts by removing all the material from the pipe to make them clean and free flowing.

Measurement and payment shall be by the linear metres of pipes de-silted, regardless of diameter size.

08 – 60 - 001/2/3/4/5: Cleaning Culverts / Structures, inlet/outlets (Partially blocked)

08 - 60 - 001	300mm dia;
08 - 60 - 002	450mm dia;
08 - 60 - 003	600mm dia;
08 - 60 - 004	900mm dia;
08 - 60 - 005	1200mm dia

This activity shall involve the cleaning of culverts of specified size including pipe barrels and the outlet/inlet structures, and the outlet drains, keeping them free of all debris, weed, silt and any obstruction to ensure free passage of water at all times. The debris shall be deposited in approved spoil dumps directed by the Engineer. ***Partially blocked culverts shall be considered as pipe culverts with less than half the barrel-blocked.***

Correct widths and slopes of the outlet drains shall be maintained. The gradient of the outlet drain shall be checked to ensure it is greater than 2 % using boning rods, line and level.

All broken culvert barrels discovered in the course carrying out this activity shall be reported to the Engineer. This activity should be carried out before the rains.

Work Method

The contractor shall use **labour** to carry out this item of work

Quality Control

The workmanship shall be visually checked and shall be clean and free of obstacles

Measurement: **m**

The unit of measurement shall be linear metre of culvert line including outlet drain cleaned

Payment

The unit rate shall be full compensation for labour, tools, as required to carry out the prescribed works.

08 – 60 - 006/7/8/9/10 : Desilting Culverts / Structures inlet/outlets (Fully blocked):

08 - 60 - 006 300mm dia;

08 - 60 - 007 450mm dia;

08 - 60 - 008 600mm dia;

08 - 60 - 009 900mm dia;

08 - 60 - 010 1200mm dia

This activity involves the cleaning of culverts of specified size including pipe barrels and the outlet/inlet structures, and the outlet drains, keeping them free of all debris, weed, silt and any obstruction to ensure free passage of water at all times. The debris shall be deposited in approved spoil dumps directed by the Engineer. **Fully blocked culvert shall be considered as pipe culvert with greater than half-of the barrel blocked.**

Correct widths and slopes of the outlet drains shall be maintained. The gradient of the outlet drain shall be checked to ensure it is greater than 2 % using boning rods, line and level

All broken culvert barrels discovered in the course of carrying out this activity shall be reported to the Engineer.

Work Method

This activity should be carried out before the onset of the rains.

Quality Control

The workmanship shall be visually checked

Measurement **m³**

Under this item the unit of measurement shall be cubic metres of material, excavated. The workmanship shall be visually checked and shall be clean and free of obstacles

Payment

The unit rate shall be full compensation for labour, and tools required to carry out the prescribed works

SECTION 9 - PASSAGE OF TRAFFIC**901 SCOPE OF THE SECTION**

The Contractor shall so arrange his work to ensure the safe passage of the Traffic at all times and if necessary construct and maintain an adequate diversion for traffic complete with all the necessary road traffic signs.

The contractor shall provide to the satisfaction of the Engineer adequate warning signs, temporary restriction signs, advance warning signs, barriers, temporary bumps and any other device and personnel shall be properly positioned well in before work is allowed to start. Signs and traffic control shall be kept in good condition and be clear to all road users to ensure the safe passage of traffic through the works.

When carrying out the Works the Contractor shall have full regard for the safety of all road users.

The Contractor shall also provide sign posts and maintain to the satisfaction of the Engineer all deviations necessary to complete the works. The contractor should allow for the costs of complying with the requirements of this clause in his rates.

Warning signs, fences, barriers, detours, etc. shall be properly positioned well in advance so that all traffic has been well and safely accommodated before work is allowed to start. Payment shall be per unit km rate through the works.

SECTION 10 – GRAVEL WEARING COURSE

GENERAL

1001

The road carriageway shall be constructed in accordance with the provisions of Section 10 of the Standard Specifications. Borrow pits and spoil areas shall comply with all the requirements of Section 6 of this specification in respect of borrow pits and spoil areas.

1002 CLASSIFICATION OF MATERIAL

Gravel wearing course material shall be material which can be extracted from a borrow area or a road cutting by ripping to a depth of 300mm with a single tine hydraulic ripper acceptable to the Engineer. The material shall have a minimum CBR of 20 at 95% MDD (AASHTO T180) and four days soak

Where directed by the Engineer new gravel will be added to the existing gravel to have the required thickness of wearing course. The existing gravel wearing course shall be cut by ripping top of the roadway to a depth of 150mm with a single tine hydraulic ripper acceptable to the Engineer.

The scarification, watering, mixing, shaping and compaction of the top 150mm of roadway materials to 95% MDD (AASHTO T99) if watering and compaction is specified. In this case the Engineer should direct the contractor to mix in any additional material. Both new and existing gravel will be mixed and bladed back over the roadway, and recompacted in accordance to the requirements given in Clause 1003 of the MOPWH Standard Specification. And such gravel shall be paid for separately under the relevant pay item allowed in the Bill of Quantities

However, where there is existing gravel wearing course, the Engineer may instruct that the Contractor blade aside and stockpile the wearing course material before commencing any of the works under this item. The contractor shall take such care as to ensure that the stockpiled gravel is not contaminated with sub grade materials, topsoil or organic material.

After carrying out the work defined in part **10.-50.004** (a) to (d) above, the contractor shall compact the formation to 95% MDD (AASHTO T99). If necessary to achieve the desired compaction, the Contractor shall scarify the formation level to a depth of 150mm, water to obtain the required moisture content, reshape and finally re-compact the material.

The gravel-wearing course shall then be bladed back over the formation to a constant thickness and re-compacted in accordance with the requirements given in Clause 1003 of the MOPWH Standard Specification.

Wherever the existing roadway width is less than specified in the document the contractor shall, if instructed by the Engineer, widen the roadway to obtain this minimum width, and excavate ditches to the template shown in the Drawings or as directed by the Engineer. Any widening works shall be paid for separately and in addition to the payment for Light Reshaping, under the appropriate earthwork item.

Quality Control

The material may be obtained from borrow pits or excavation in cuttings. The plasticity requirements and the class of material shall be as specified in Table 10.1 and the Special specification.

Table 10.1: Requirement for Gravel Wearing Course

GRADING REQUIREMENTS AFTER COMPACTION	
Sieve (mm)	% by Weight Passing
40	100
28	95 - 100
20	85 - 100
14	65 - 100
10	55 - 100

PLASTICITY INDEX REQUIREMENTS PI		
Zone	Min	Max
WET	5	20
DRY	10	30

5	35 - 92
2	23 - 77
1	18 - 62
0.425	14 - 50
0.075	10 - 40

BEARING STRENGTH REQUIREMENTS		
Traffic Commercial VPD	CBR	DCP Equivalent mm/Blow
≥ 15	20	11
≤ 15	15	14
CBR at 95 % at MDD, Modified AASHTO and 4 days soak		
Lower quality material (CBR 15) may be accepted if no better material can be found		

NB: Wet Zone - mean annual rainfall greater than 500 mm.

Dry zone - mean annual rainfall less than 500 mm.

The Contractor shall be responsible for the acquisition of the quarry rights and shall therefore conduct respective negotiations with landowners and affected communities. The Engineer shall approve quarries and their extent of exploitation.

Alternative sources of gravel material whose quality can be shown to be in compliance with the specification requirements may be used, with the proviso that the Employer is not to incur additional expenses in connection with its winning and haulage. Contractor is deemed to have included in his rates for the provision of the gravel material to have included the cost of complying with the testing requirements.

10.-.50.004 Light Grading

Grading covers the works involved in the reinstatement of the road carriageway to the camber by removing the high points and filling up gullies corrugations and wheel ruts to restore smooth running surface.

Light grading shall only be undertaken where ordered by the Engineer.

Light grading is the restoration of the road profile and existing side drainage/mitre drains including the shaping of the formation, recompaction and, if applicable, the reshaping and recompaction of the gravel wearing course.

These operations shall be carried out using the following plant:

- a motor grader of at least 120 HP(for light grading alone)
- a roller, sufficient to achieve the required compaction(if compaction required it shall be included in the BOQ's)
- a water tanker to obtain the required moisture content for compaction. if watering required it shall be included in the BOQ's)

The works to be carried out under this item are as follows.

- (a) Removal of vegetation, topsoil and landslips form with the limits of the roadway and side drains, whatsoever the width.
- (b) The reshaping of the longitudinal profile of the roadway, including the removal of ruts, humps and windrow, and the filling of potholes.
- (c) The reshaping of the roadway and ditches to the specified cross-section template, as directed by the engineer, including the reinstatement of existing side ditches and mitre drains.
- (d) The clearing of all loose material from side slopes to fills and cuts.

10.-.50.002 Heavy grading

Heavy Grading shall only be undertaken when directed by the Engineer.

Heavy Grading is the restoration of the road profile, template and side ditches and involves operations similar to what is required for Light Grading. Heavy grading demands the following works in addition to the works specified above Light grading:

- (a) Correction of undulations, deep rutting, and gullies whatever their depth;
- (b) The drainage of quagmires; the removal and disposal of water logged material;
- (c) The clearance of landslips from the roadway and ditches;
- (d) Where directed by the Engineer, the widening of the roadway by either cutting or filling, or both.
- (e) The improvement of the longitudinal profile of the road by the excavation of humps and the filling of holes and depressions.

The following equipment shall be used in this works:

- a motor grader of a at least 120 HP
- a bulldozer of at least 150 HP
- a water tanker
- a self-propelled roller of at least 10 tonnes dead weight, or a vibrating roller of at least 3 tonnes dead weight.

Any fill required for the reshaping of the road profile, the elimination of ruts, gullies and holes and the replacement of waterlogged material shall be obtained from either within the road prism or from cut slopes and adjacent to the road, provided that the material conforms to the requirements of this Specification and meets with the approval of the Engineer.

Any excavation in hard material will be deemed to be in addition to the work requirements for Heavy Reshaping and will be paid for separately under the appropriate earthworks item.

Table 10.2: Overall widths ditch to ditch (Guidelines)

<i>Road Category</i>	<i>Carriageway width</i>	<i>Overall width to front of Ditches</i>
A/B/C + Secondary Roads	6.0 m	8.4
D/E + Minor Roads	5.4 m	7.8 m
RAR Roads	4.5 m	6.5 m
Minor / RAR roads with insufficient widths or Temporary Sections	3.5 m	5.5 m

Work Method

The contractor shall use **equipment** to carry out this item work.

Quality Control

Grading

- Gradient of the ditch shall be checked at 20m interval using boning roads and shall drain to the natural drainage channels or mitre drains placed at regular intervals.
- The width of the carriageway (see table 10.2) shall be checked using tape measure at every 50m with tolerance of +50mm or -20mm
- The camber shall be checked using camber board at every 50m with and shall have a tolerance of +/- 1%

Compaction

Compaction of the reshaped or reformed road shall be by not less than 8 passes as and directed by the Engineer depending on the compaction equipment used. Unless otherwise instructed, the moisture content at the time of compaction shall be within the range of +/- 2% of the optimum moisture content.

Where water needs to be added, it shall be applied in an even manner and the rate of application shall be such that no traverse or longitudinal flow occurs. The Contractor is required to provide all water for compaction and shall include this in his or her rates.

- Unsuitable material should not be used;
- Compaction shall be carried out using either dead weight or pedestrian rollers of approved weight and dimensions.
- The minimum passes of compaction to applied shall be that which no more roller imprint on the surface can be seen and to a minimum dry density as given in table 5.0 below;
- The camber shall be checked at 100m intervals using camber board and a line level and shall not be less than 5 % with a tolerances of +/- 1%
- Material for compaction shall be placed in layers of 200mm loose depth unless otherwise directed. The layers shall be parallel to the top of the subgrade level.

Table 10.3 : Minimum dry density

Layer location.	Minimum compaction
Excavation to level platform	95% MDD (AASHTO T99)
Road formation and fill material	100% MDD (AASHTO T99)
Gravel wearing course	95% MDD (AASHTO T180)

Measurement: _____ m²

The unit of measurement for mitre drains and compaction shall not be paid for separately and shall be deemed to be covered in his rates for grading

Payment

The unit rate compaction shall be the full compensation for labour, equipment and any incidental costs required for carrying out the works to the required specifications.

SECTION 20 - ROAD FURNITURE**2001 ROAD RESERVE BOUNDARY POSTS**

Road reserve boundary posts shall be provided as directed by the Engineer and in compliance with Standard Specification clause 2001.

2003 EDGE MARKER POSTS

Edge marker posts shall be provided as directed by the Engineer and in compliance with standard Specification Clause 2003.

2004 PERMANENT ROAD SIGNS

Permanent Road Signs shall be provided as directed by the Engineer and in compliance with the requirements of the "Manual for Traffic Signs in Kenya" Part II and standard Specification clause 2004.

2004B EXISTING ROAD SIGNS

Where directed by the Engineer, the Contractor shall take down road signs including all posts, nuts, bolts and fittings, and remove and dispose of the concrete foundation and backfill the post holes. The signs shall be stored at the Contractor's store and they shall become the property of the Employer who shall remove them prior to the expiry of the maintenance period.

Measurement and payment for taking down road signs shall be made by the number of signs of any type and size taken down, cleaned and stored as directed.

Where a salvaged existing sign complies with the requirements of new road signs, the Engineer may instruct the Contractor to remove the sign for safe storage, and re-erect it.

Measurement and payment shall be made by the number of road signs re-erected as directed and the rate shall include for excavation, concrete foundations and backfilling around posts and removal of surplus material to spoil.

2005 ROAD MARKING

Paint for road marking shall be internally reflectorised hot applied thermoplastic material in accordance with Clause 218 d(ii) of the Standard Specification.

The rates inserted in the Bills of Quantities for road marking shall include for prior application of approved tack coat.

2006 GUARDRAILS

Contrary to the Standard Specification, guardrail posts shall be concrete 200 mm diameter set vertically at least 1.2m into the shoulder as directed by the Engineer. Spacer blocks shall also be made of concrete.

Beams for guardrails shall be "Armco Flex beam" or similar obtained from a manufacturer approved by the Engineer.

2007 KERBS**a) Vertical Joints**

Vertical joints between adjacent Kerbs shall not be greater than 5 mm in width and shall be filled with a mortar consisting of 1:3 cement: sand by volume.

b) Transition between flush and raised kerbs

The transition between flush and raised kerbs (e.g at bus bays) shall be termed as ramped kerbs. The transition between flush and raised kerbs shall occur within a length of 2.0 m.

2008 KILOMETRE MARKER POSTS

Kilometre marker posts shall be provided as directed by the Engineer and in compliance with Standard Specification clause 2008.

2009 RUMBLE STRIPS

Where directed by the Engineer, the Contractor shall provide, place, trim, shape and compact to line and level asphaltic concrete rumble strips on the finished shoulders. This shall be done to the satisfaction of the Engineer

2010 BOLLARDS

Where directed by the Engineer, the Contractor shall provide, and install class 20/20 200mm diameter reinforced concrete Bollards concreted 300mm into the ground.

SECTION 22: DAYWORKS

This section covers provisional items included in the Bills of Quantities to cover the payment of equipment, labour and materials for work instructed by the Engineer on a daywork basis.

22- 001 : Dayworks

Measurement and Payment

5 Equipment:

Payment for equipment shall only be made for the time each item of equipment is actually working. Idle time due to breakdown or incompleteness of the equipment shall not be paid for. The rate of equipment shall include for the cost of the following:-

- i) Transport of the equipment to the site
- ii) Operators , drivers and assistants including their overtime
- iii) Maintenance, spare parts and all costs of repairs
- iv) Depreciation insurance, overheads and profits.

6 Labour

Payment shall only be made for the time each of worker labour is actually working on the daywork instructed by the Engineer. The rate for labour shall include the cost of the following:-

- i) All salaries allowances and other payments required by the worker
- ii) Provision of small tools used on dayworks such as picks, shovels, pangas, jembes hammers chisels and all other tools used by tradesmen.
- iii) Insurance, overheads and profit.

7 Materials

Payment shall only be made for materials instructed by the Engineer for use in dayworks. The rate for materials shall include for the cost of provision of the material, transport to site and storage handling overheads and profits.

Use of Dayworks

The use of Dayworks shall be **only** sanctioned by the Authorized Person for extra and substituted works and at the rates approved by the Ministry of Roads for the current period.

**SECTION VX:
CONTRACT DRAWINGS**

FIGURE C.1 - CROSS SECTION A (MINOR STANDARD)

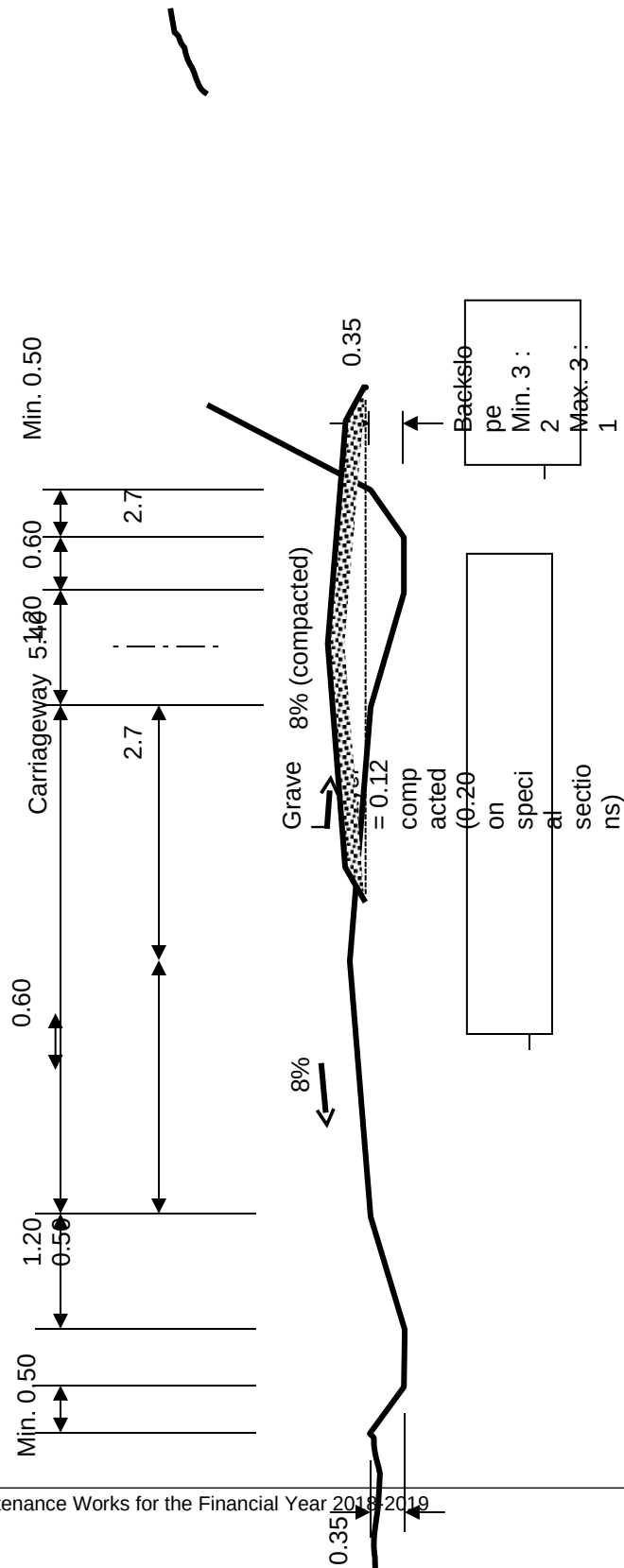

NOTE:
 - ALL SPECIFIED DIMENSIONS IN m.
 - TRAFFIC LEVELS OF MORE THAN 200 VPD MAY JUSTIFY RUNNING SURFACE WIDTH INCREASE TO 6.50 METRES

FIGURE C.2 - CROSS SECTION B (REDUCED CROSS-SECTION)

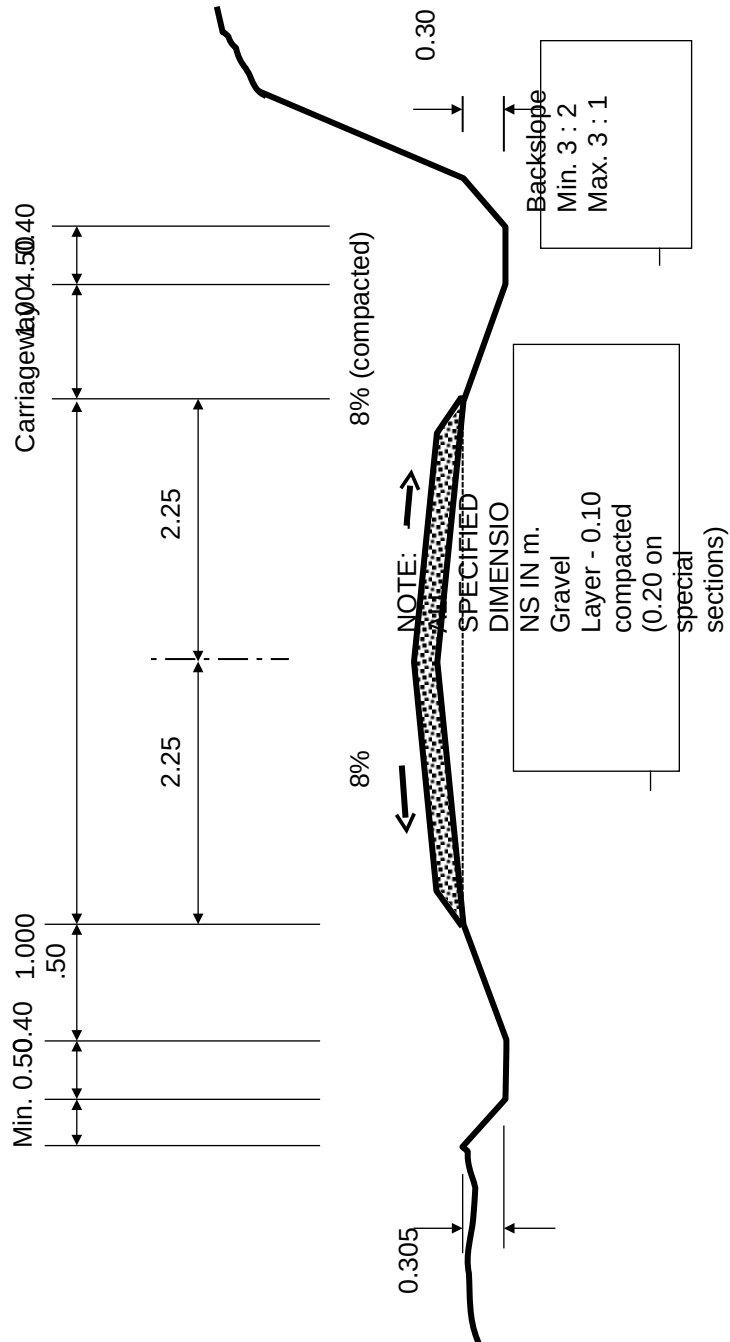

FIGURE C.3 - MITRE DRAINS

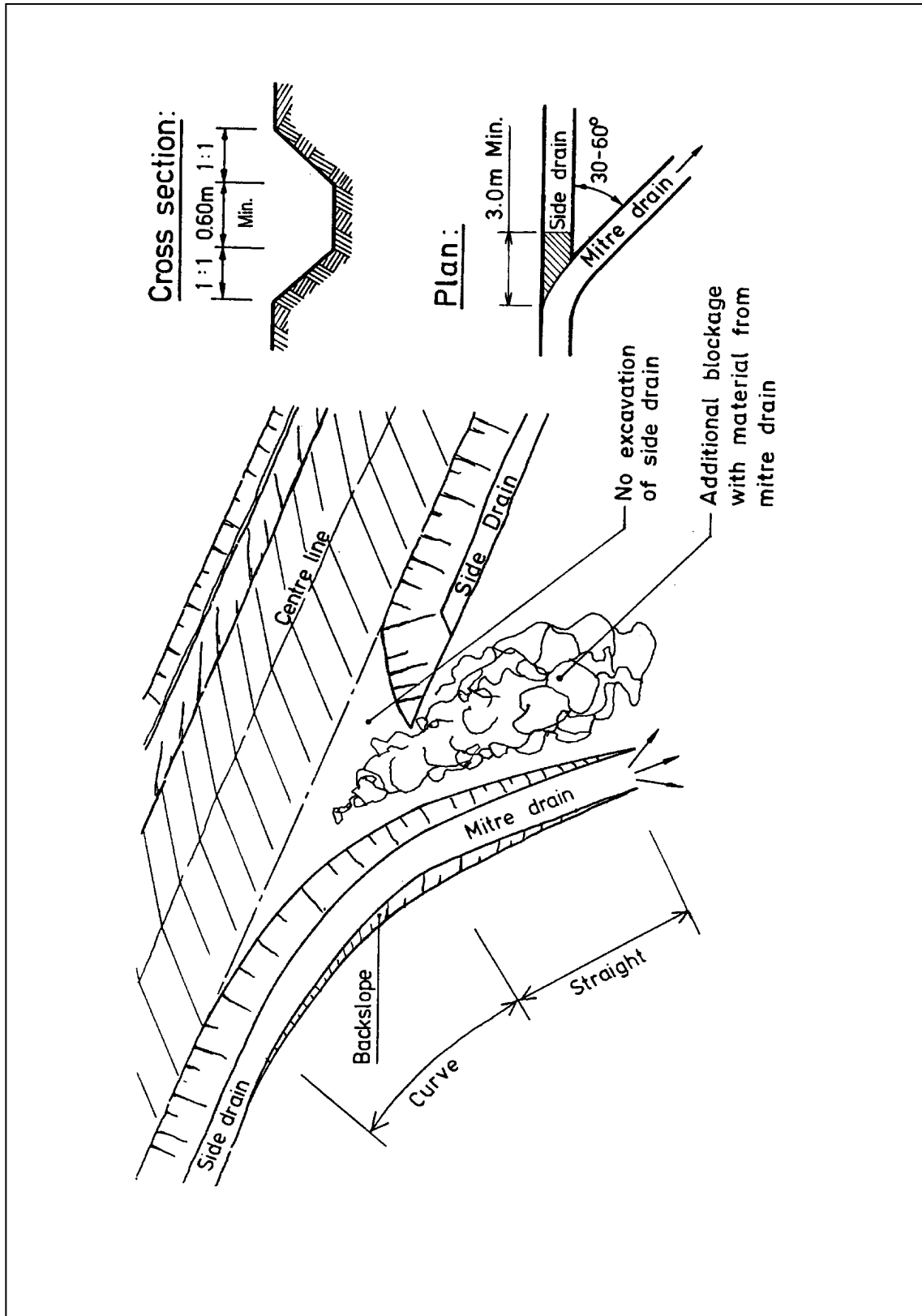

FIGURE C.4 - SCOUR CHECKS

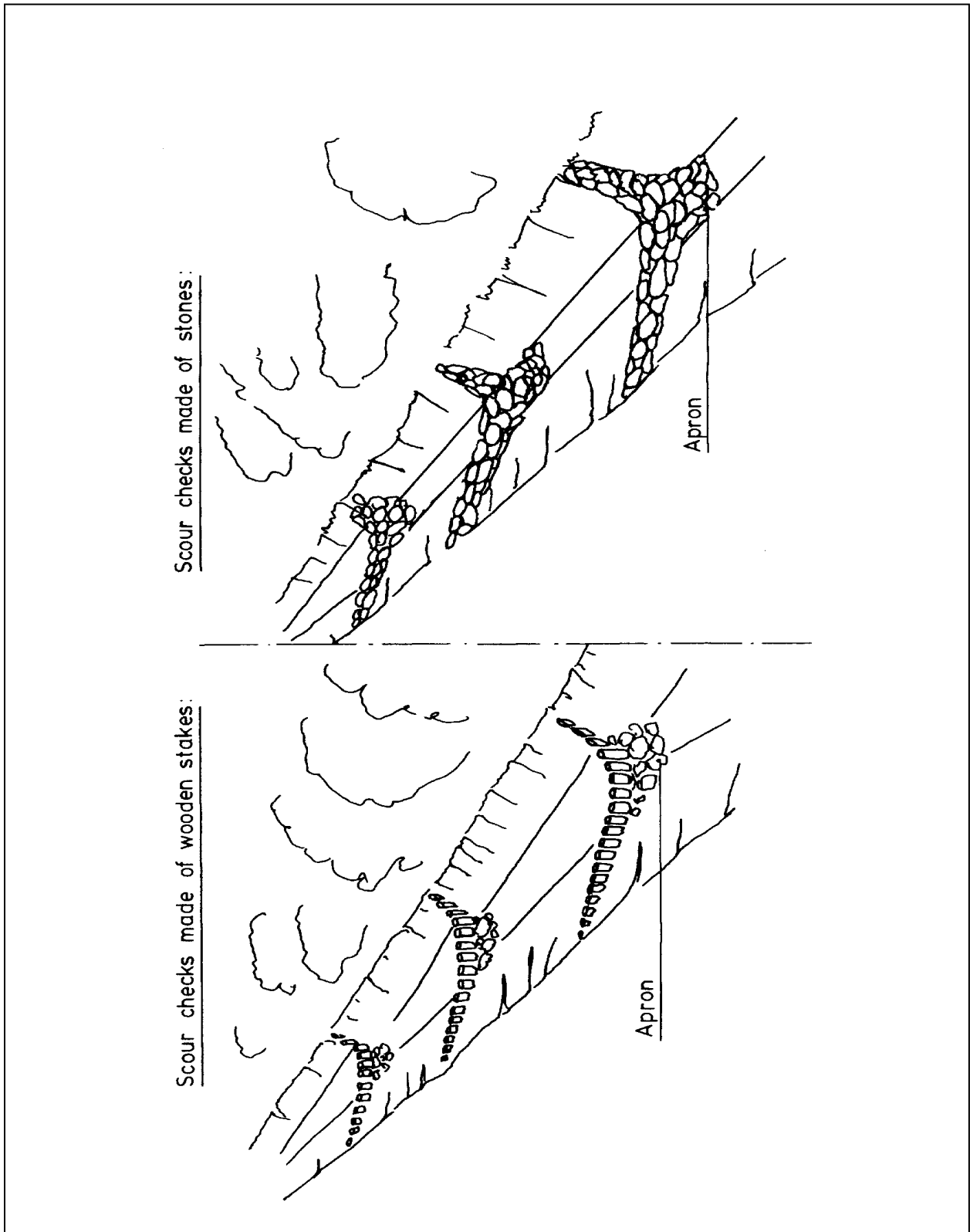

FIGURE C.5 - DIMENSIONS OF SCOUR CHECKS FOR STANDARD DRAIN

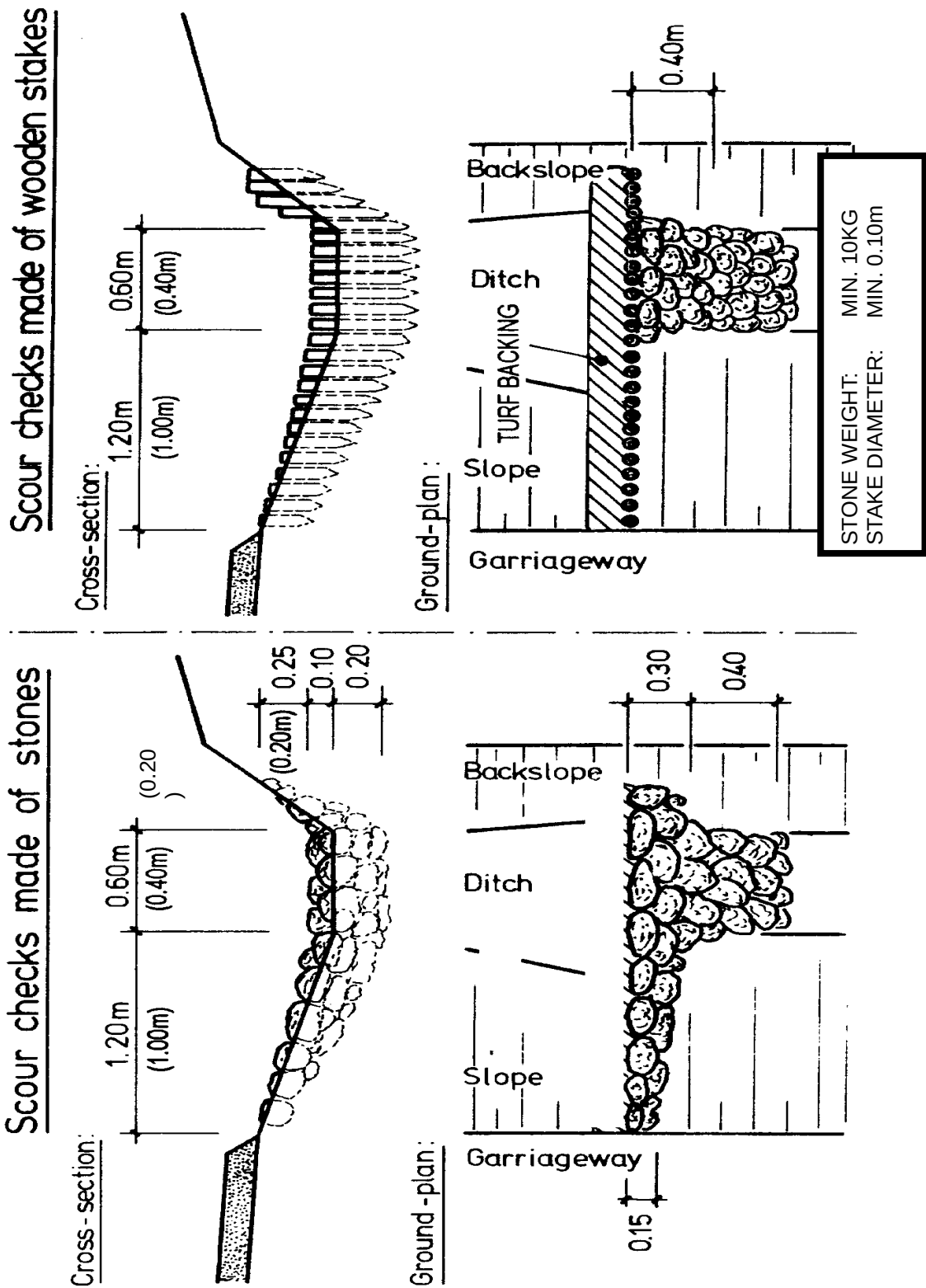
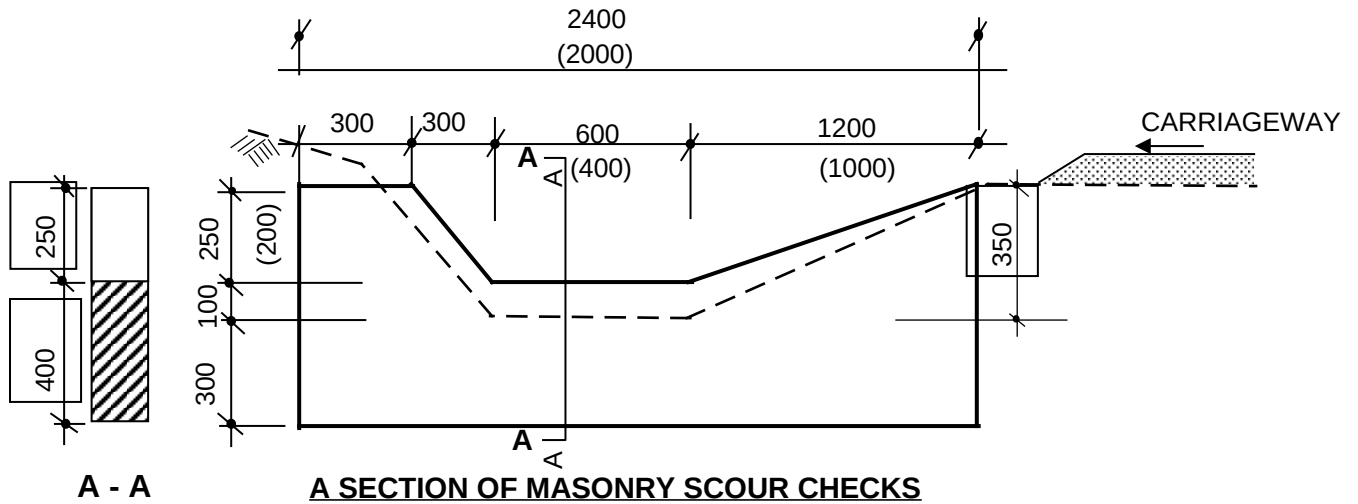
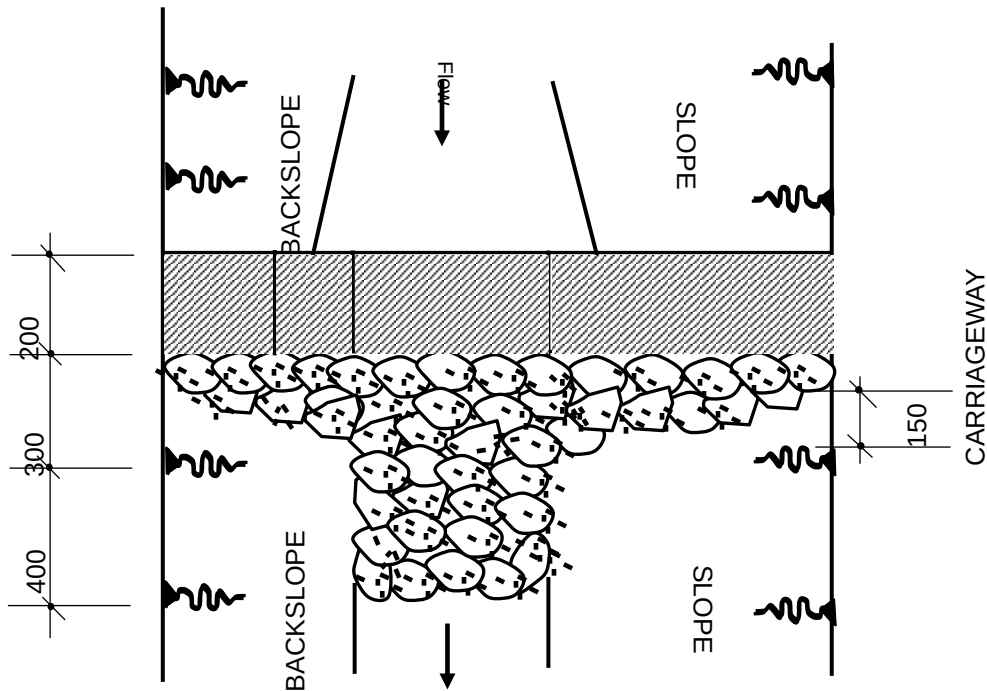

FIGURE C.6 - MASONRY SCOUR CHECKS



A SECTION OF MASONRY SCOUR CHECKS



PLAN OF DRAIN WITH EROSION CHECKS

QUANTITIES TABLE

Cross-Section	Sizes in mm			Excav. (m ³)	Stone masonry (m ³)	Apron stone pitching (m ³)
	Length	Width	Depth			
A	2400	200	550	0.22	0.25	0.18
B	2000	200	500	0.18	0.2	0.14

FIGURE C.7 - CULVERT ENTRY / EXIT STRUCTURE TYPES

TYPE 1 (ENTRY AND EXIT)

TYPE 1 (ENTRY AND EXIT)

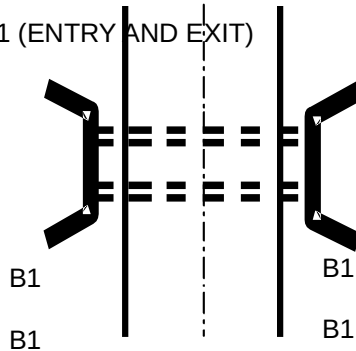

TYPE 3 (ENTRY AND EXIT)

TYPE 3 (ENTRY AND EXIT)

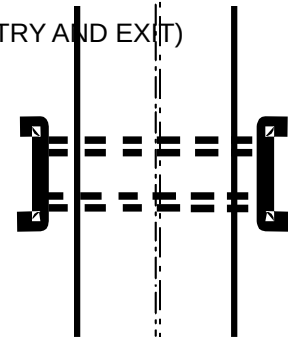

TYPE 2 (ENTRY ONLY!)

TYPE 2 (ENTRY ONLY!)

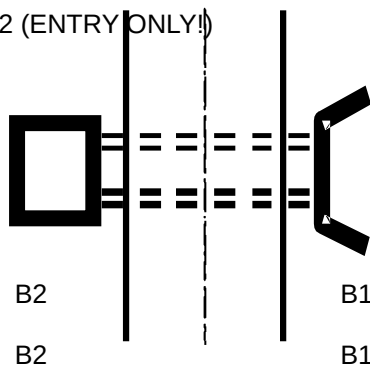

TYPE 4 (ENTRY AND EXIT ON ACCESS)

TYPE 4 (ENTRY AND EXIT ON ACCESS)

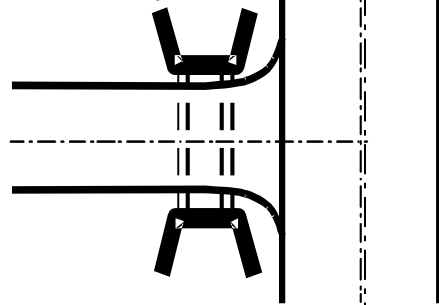
**NOTE:**

Coding system has been used in describing the standardised designs of the various culvert entry and exit structures. The code names consist of a number to specify shape and function as elaborated in above while the used construction materials are identified through an alphabetic symbol as follows:

- A = Concrete block**
- B = Stone masonry**
- C = Dressed stones**

An example code of “B2” would therefore stand for a drop inlet type structure to be built in stone masonry.

**FIGURE C.8 -
HEADWALL TYPE 1
(HEAD AND
WINGWALLS)**

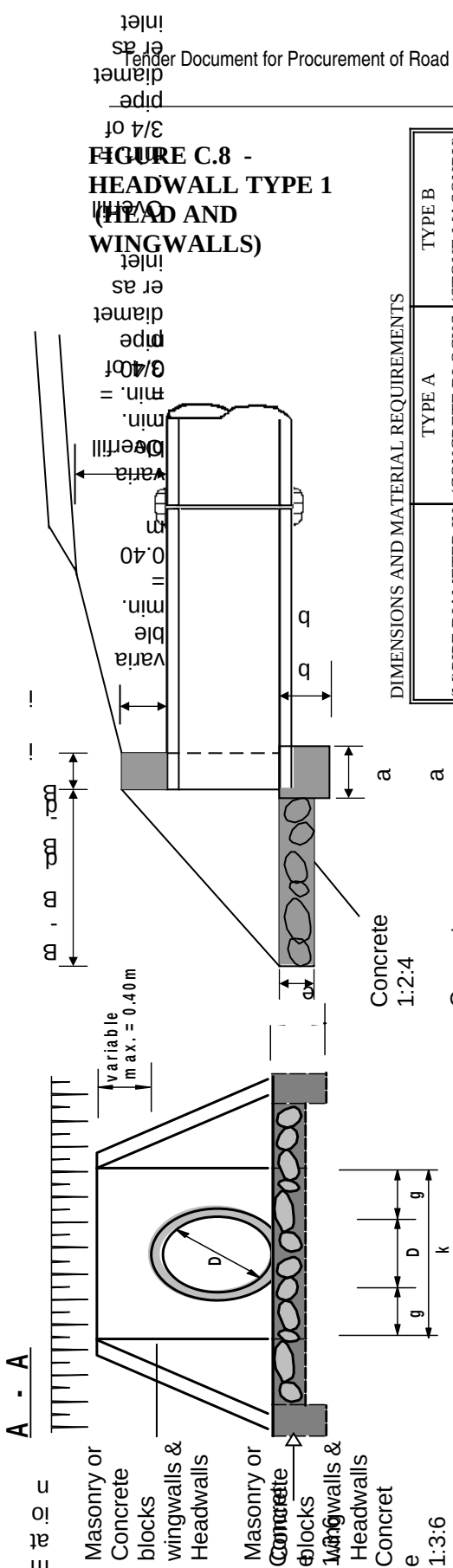

DIMENSIONS AND MATERIAL REQUIREMENTS

DIMENSION	UNIT	TYPE A (CONCRETE BLOCKS)			TYPE B (STONE MASONRY)		
		450	600	900	450	600	900
a	FOUNDATION	0.30	0.30	0.30	0.40	0.40	0.60
b	FOUNDATION	0.30	0.30	0.40	0.30	0.30	0.40
c	FOUNDATION	2.20	2.35	2.89	2.20	2.35	2.89
d	APRON	1.00	1.00	1.20	1.00	1.00	1.20
e	APRON	0.20	0.20	0.20	0.20	0.20	0.20
f	WALL	0.20	0.20	0.20	0.40	0.40	0.40
g	WALL	0.30	0.30	0.30	0.30	0.30	0.30
h	WALL	1.15	1.15	1.39	1.15	1.15	1.39
i	WALL	0.20	0.20	0.20	0.40	0.40	0.40
k	APRON	1.05	1.20	1.50	1.05	1.20	1.50

MATERIAL REQUIREMENT		TYPE A (CONCRETE BLOCKS)			TYPE B (STONE MASONRY)		
	UNIT	450	600	900	450	600	900
FOUNDATION (Concrete)	m ³	0.3	0.32	0.51	0.4	0.42	1.03
HEAD/ WINGWALL (Concrete/Masonry)	m ³	0.4	0.47	0.67	0.8	0.93	1.35
APRON (Concrete)	m ³	0.33	0.36	0.53	0.33	0.36	0.53

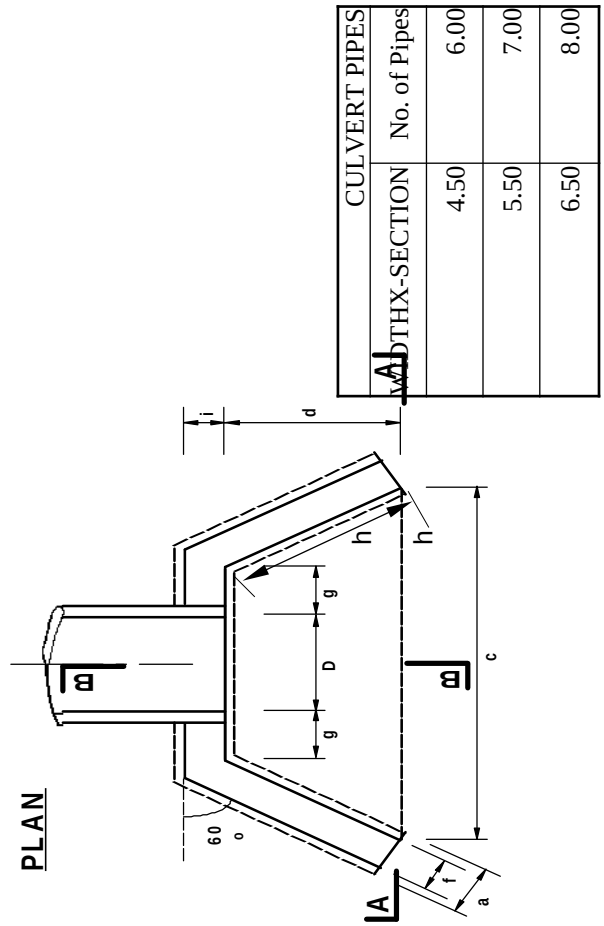

CULVERT PIPES	
WIDTH-SECTION	No. of Pipes
4.50	6.00
5.50	7.00
6.50	8.00

Road Maintenance Works for the Financial Year 2018-2019

FIGURE C.9 - HEADWALL TYPE 2 (DROP INLET)

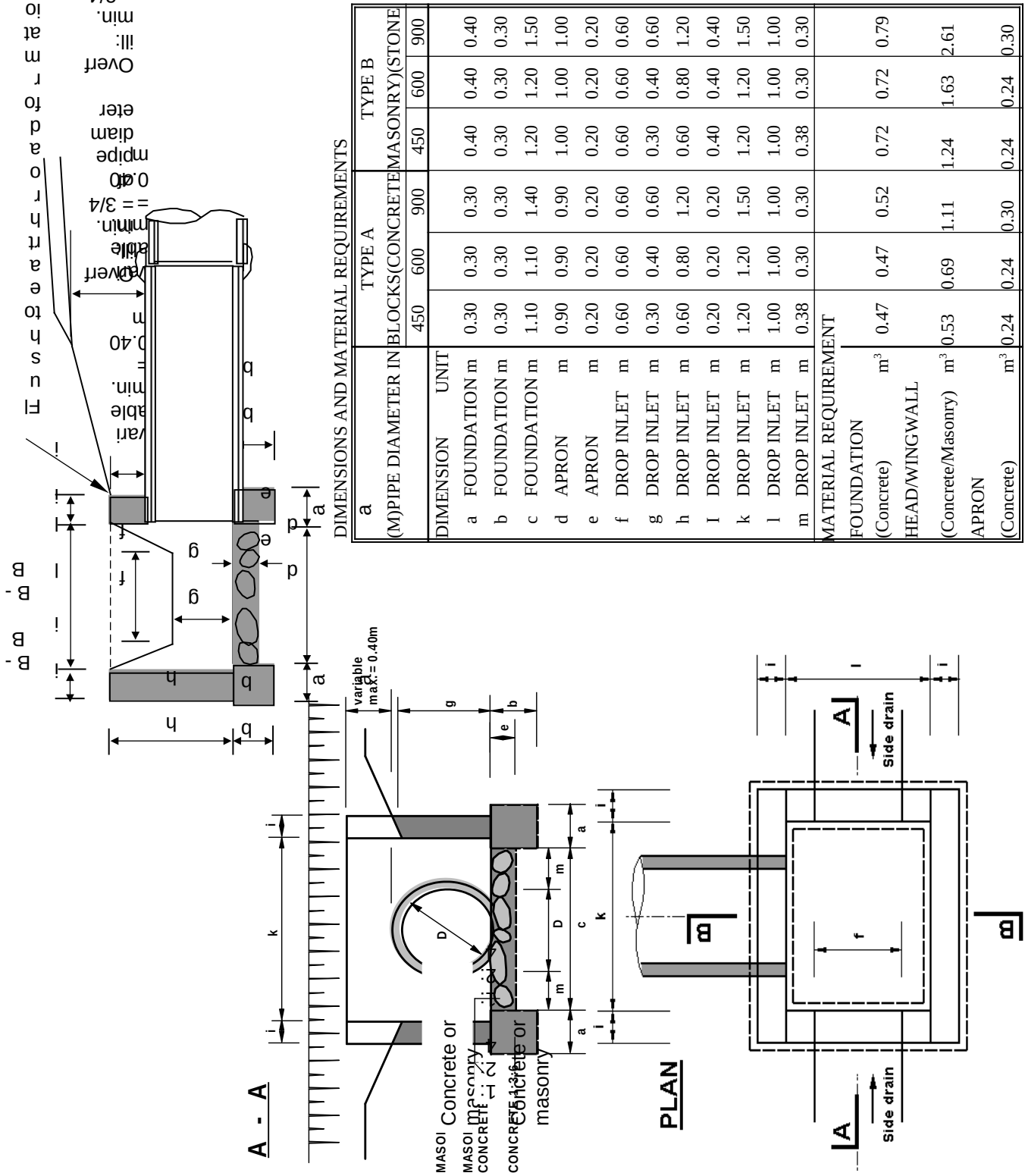

FIGURE C.10 - HEADWALL TYPE 3A (CONCRETE BLOCK HEADWALLS)

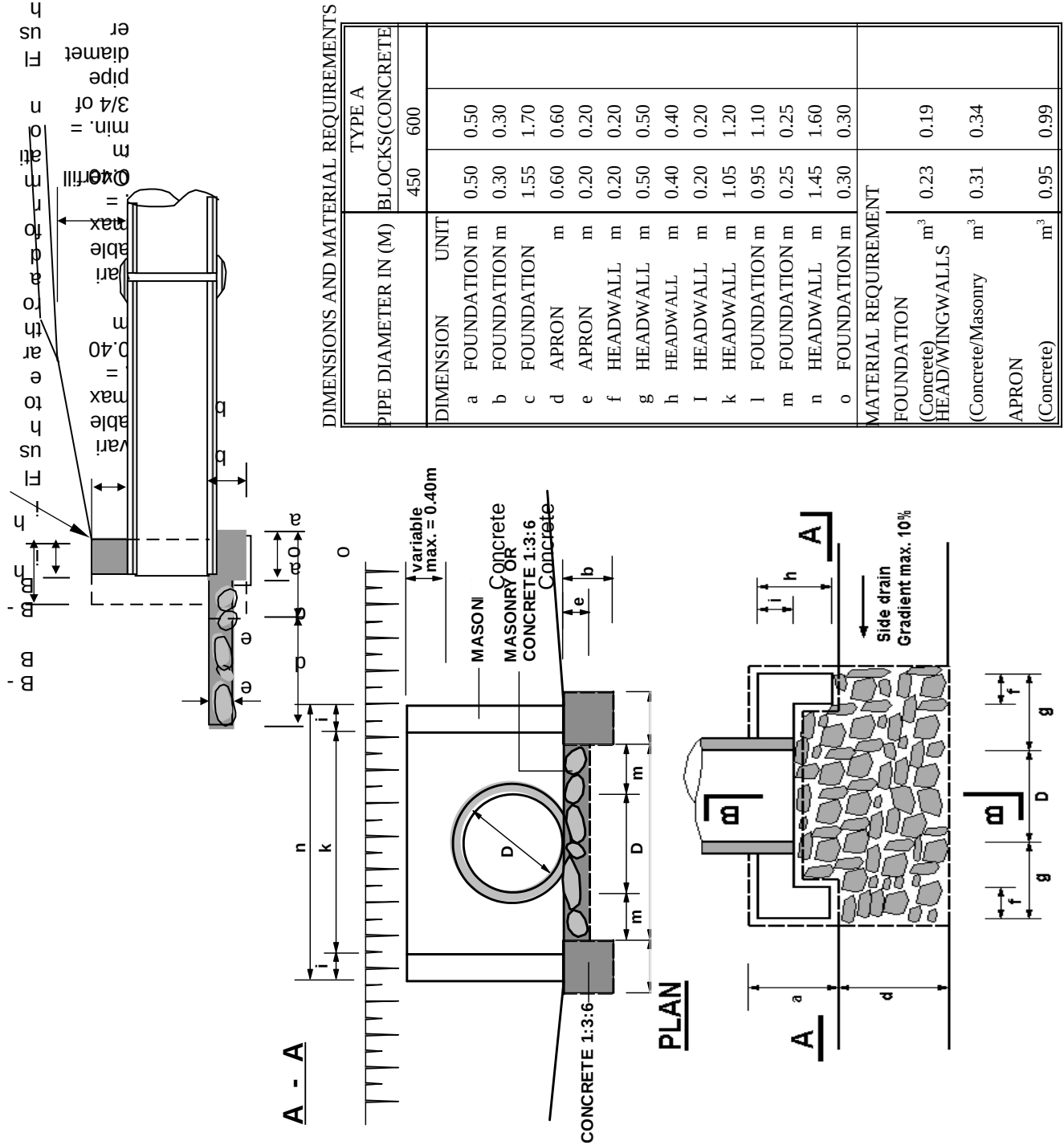
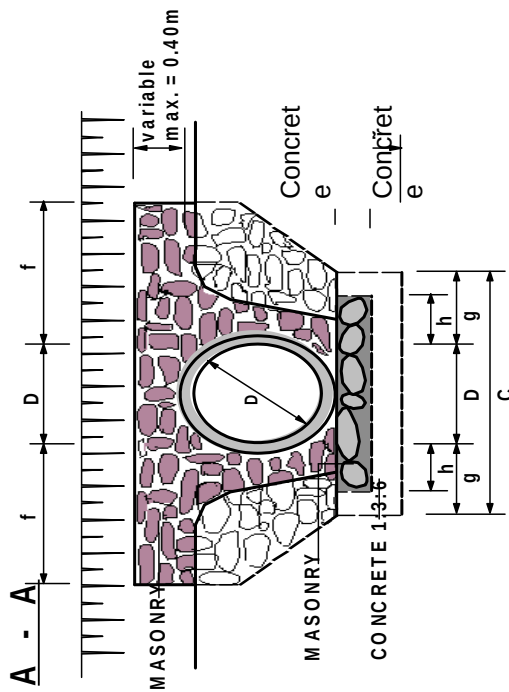
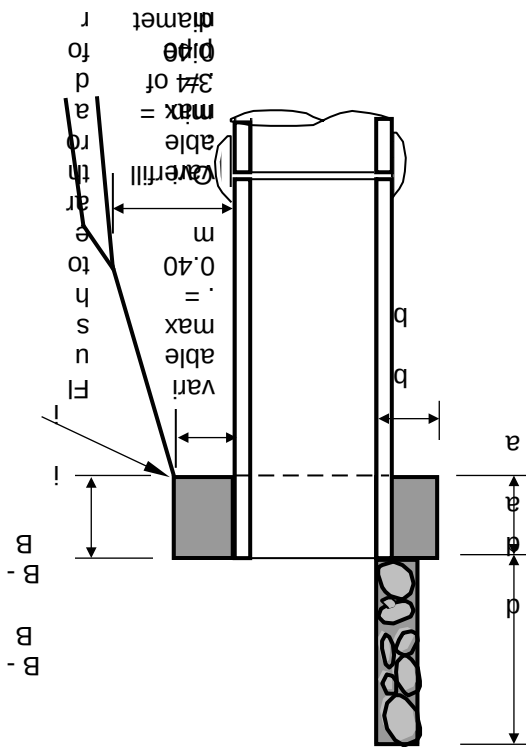
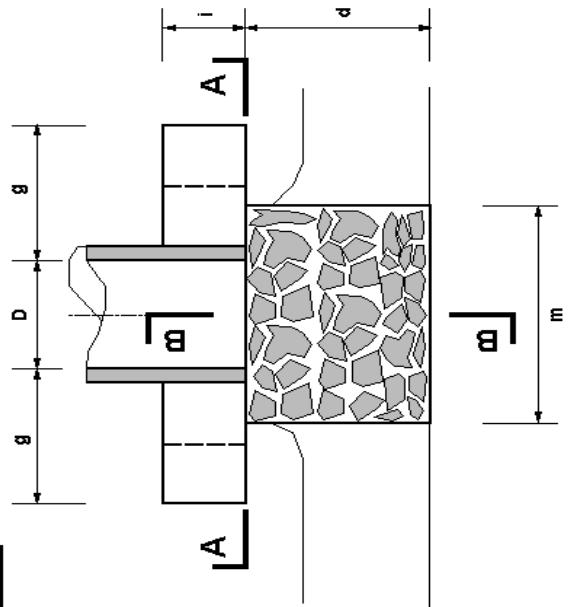

FIGURE C.11 - HEADWALL TYPE 3B (STONE MASONRY HEADWALLS)



PLAN



DIMENSION	UNIT	BLOCKS)TYPE B (CONC.	
		450	600
a	FOUNDATION m	0.40	0.40
b	FOUNDATION m	0.30	0.30
c	FOUNDATION	1.55	1.70
d	APRON m	0.90	0.90
e	APRON m	0.20	0.20
f	HEADWALL m	0.75	0.75
g	HEADWALL m	0.50	0.50
h	HEADWALL m	0.30	0.30
i	HEADWALL m	0.40	0.40
m	FOUNDATION m	1.05	1.20
MATERIAL REQUIREMENT			
FOUNDATION			
(Concrete 1:3:6) m ³		0.19	0.2
HEAD/WINGWALLS			
(Concrete/Masonry) m ³		0.62	0.69
APRON			
(Concrete 1:2:4) m ³		0.19	0.22

FIGURE C.12 - HEADWALL TYPE 4 (FOR ACCESS CULVERTS)

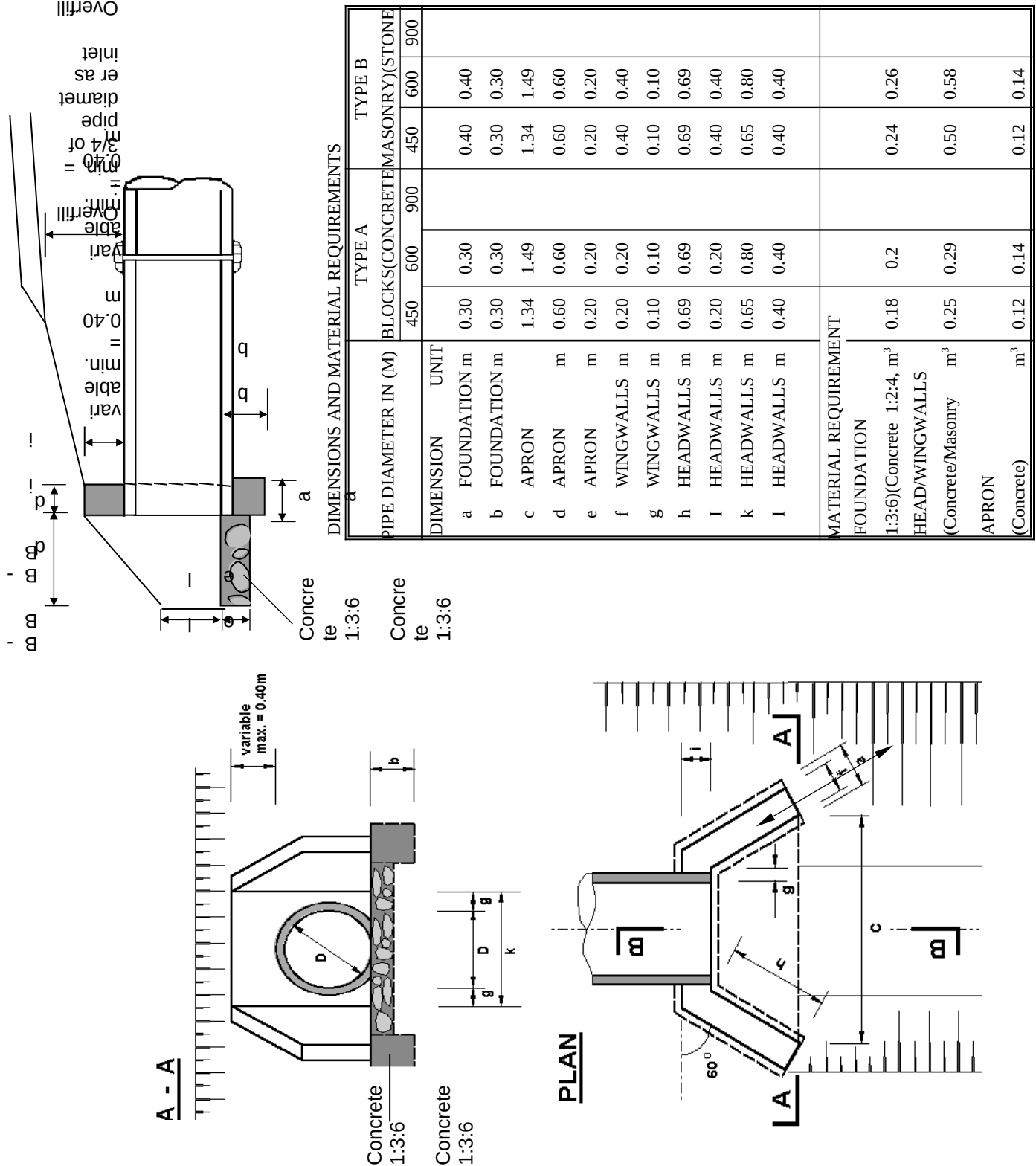
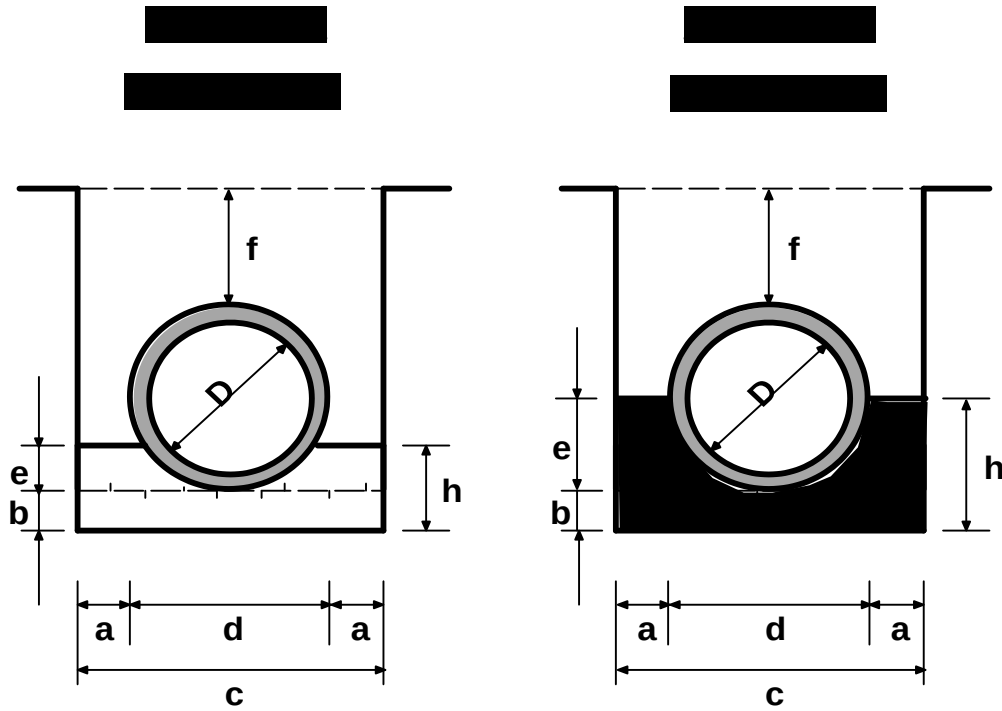
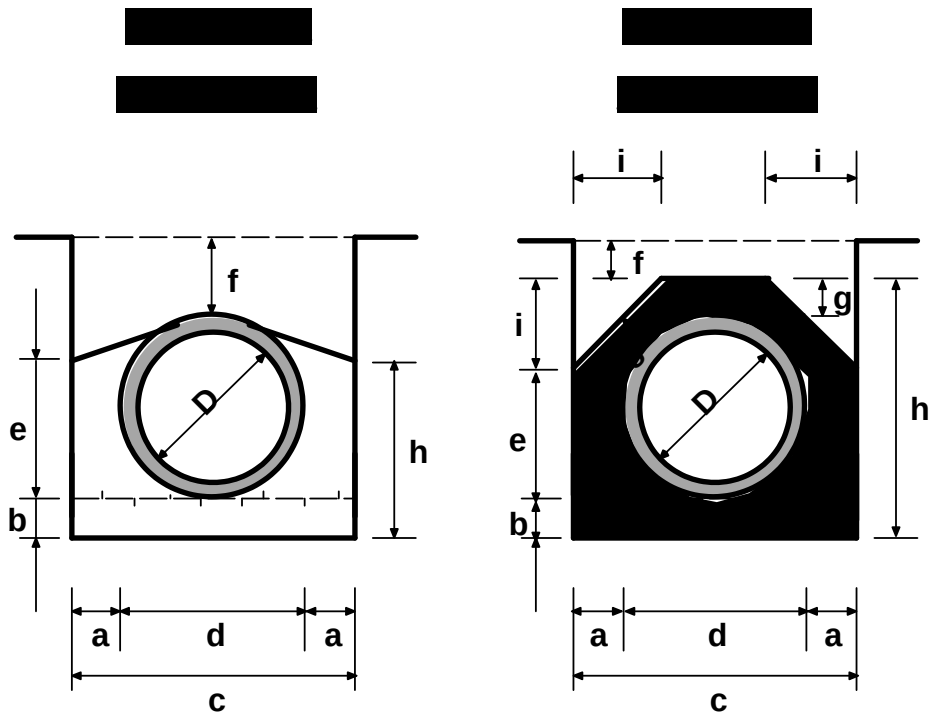

FIGURE C.13- BEDDING AND HAUNCH PROFILES TYPES I & II



450 (mm)	600 (mm)	900 (mm)
Dimensions in (m)		
0.15	0.2	0.2
0.1	0.15	0.15
0.86	1.12	1.48
0.56	0.72	1.08
0.28	0.36	0.54
0.34	0.45	0.68
-	-	-
0.38	0.51	0.69
-	-	-
Volume in (m ³ /m)		
0.2	0.37	0.56
- Fair to poor subgrade Condition; - Overfill > ¾ Diameter; - Seasonal waterflow only. - Use gravel material for back/ overfill.		

FIGURE C.14 - BEDDING AND HAUNCH PROFILES TYPES III & IV



450 (mm)	600 (mm)	900 (mm)
Dimensions in (m)		
0.15	0.2	0.2
0.1	0.15	0.15
0.86	1.12	1.48
0.56	0.72	1.08
0.46	0.52	0.78
0.15	0.15	0.15
0.15	0.15	0.15
0.81	1.02	1.38
0.28	0.35	0.45
Volume in (m ³ /m)		
0.37	0.61	0.92
- Fair to poor subgrade Condition; - Overfill > ¾ Diameter; - Seasonal waterflow only. - Use gravel material for back/ overfill.		

FIGURE C.15 ACCESS DRIFT

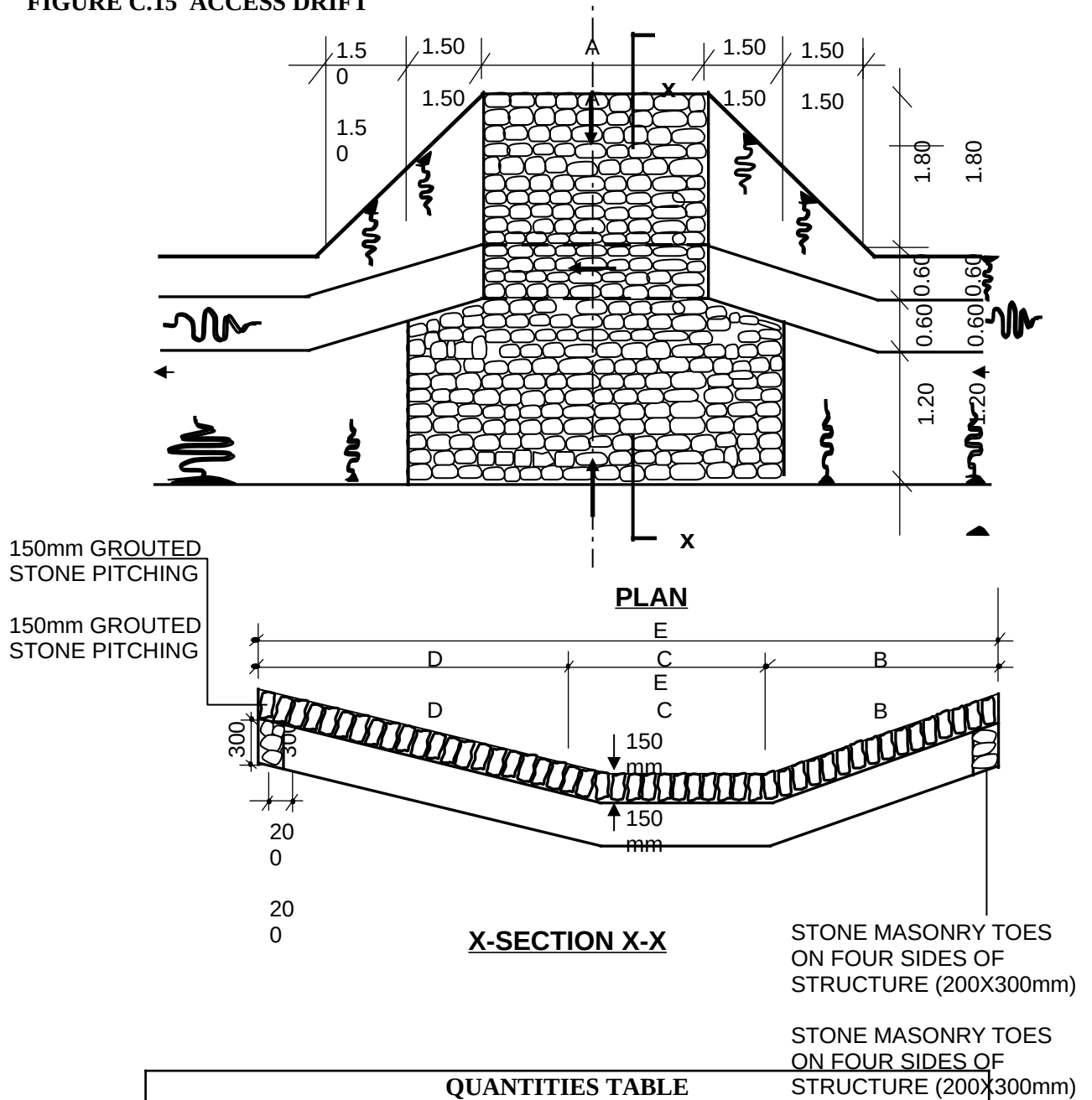

QUANTITIES TABLE								
Cross section	DIMENSIONS					Excavation (m3)	Stone masonry (m ³)	150mm Grouted stone pitching (m3)
	A	B	C	D	E			
A	4000	1800	600	1800	4200	7.50	1.30	21.75
	6000	1800	600	1800	4200	10.00	1.60	30.15
B	4000	1400	400	1800	3600	7.00	1.20	18.30
	6000	1400	400	1800	3600	9.00	1.50	25.50

FIGURE C.16 - TRAFFIC SIGNS

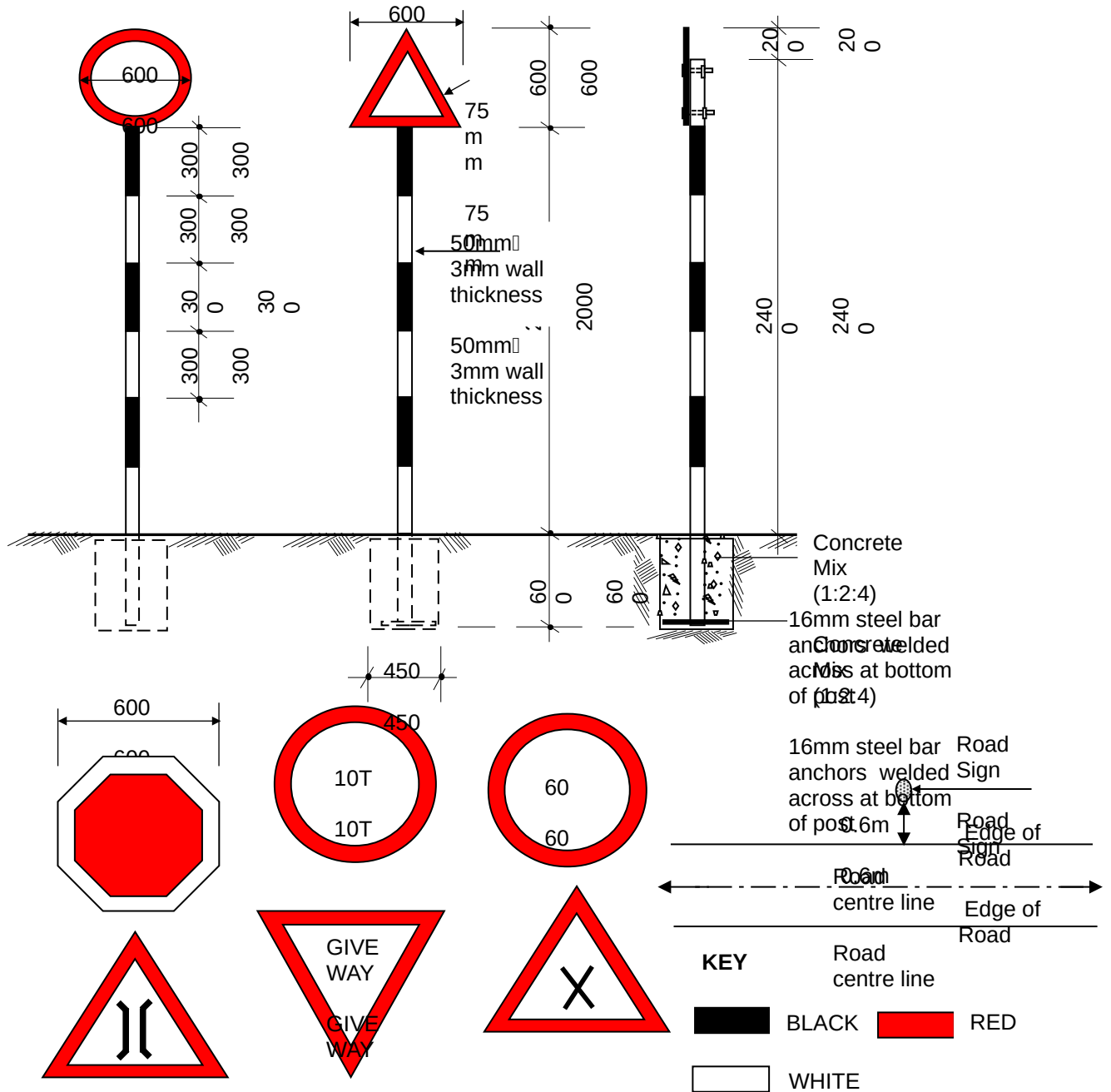

1. The type of sign required and their location shall be as shown on the improvement plan and as directed by the Engineer
2. Sign plate to be 2 mm thick mild steel plate
3. Sign post to be 50 mm internal diameter steel pipe with wall thickness of 3 mm.
4. Sign plate to be fixed to steel tube by 4 Nos M10 bolts and 2 Nos 50 mm fixing clamps/brackets.
5. Sign paints shall be reflective.
6. The sign plate and post shall be treated by applying two coats of lead red oxide paint before applying priming and two finish coats of approved paints. Paints used shall have a hard, durable and glossy finish.

FIGURE C.17 - PUBLICITY SIGNBOARD

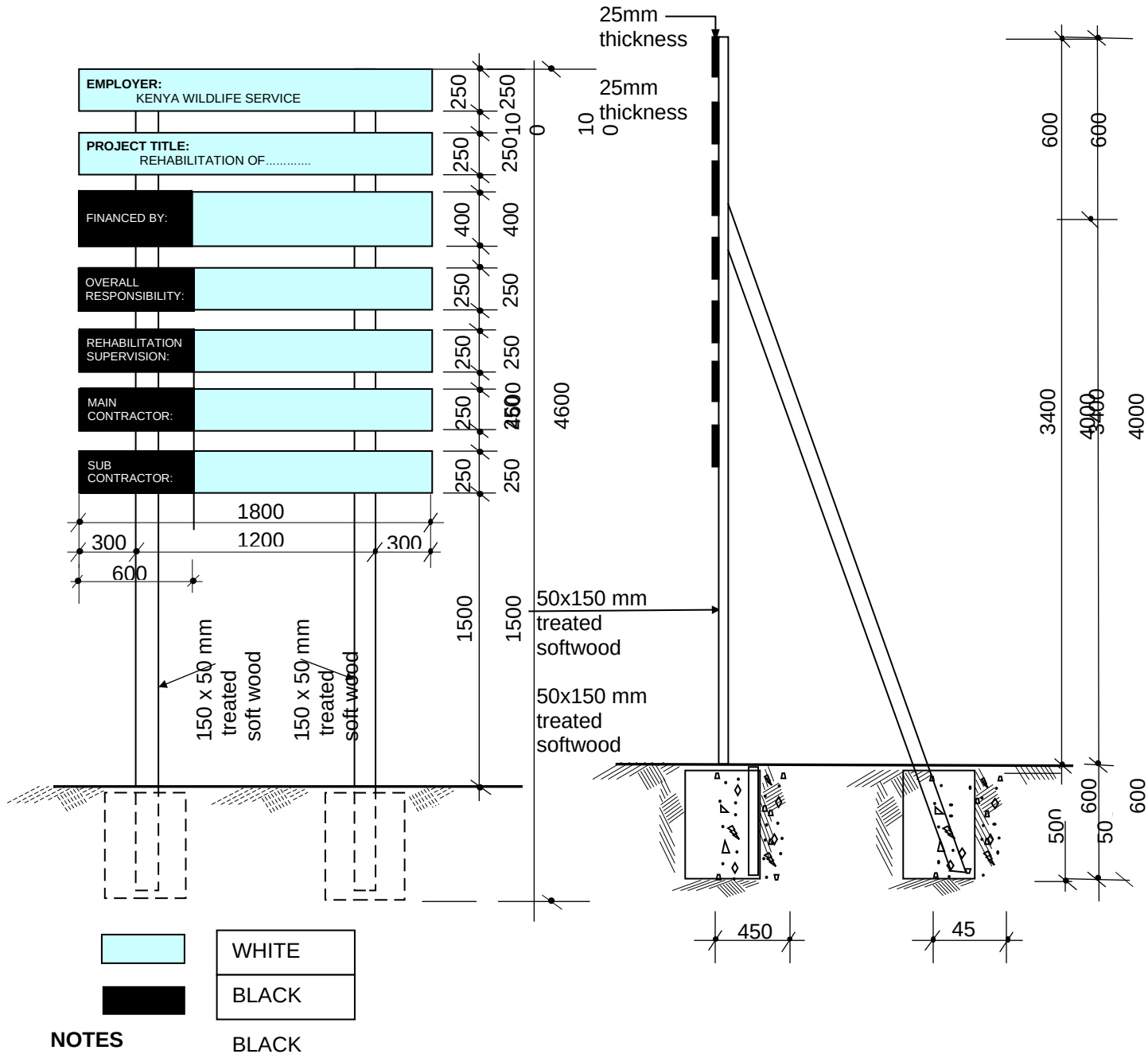

1. The wording of the project signboard and the location to be installed to be as directed by the Engineer
2. Materials to be used for fabrication of signboard shall be pressure impregnated treated softwood timber sizes as indicated in the drawing
3. Wording boards to be nailed to the posts using nails.
4. Project board posts and struts to be embedded in concrete ratio 1:2:4

SECTION XI

BILLS OF QUANTITIES

(These are attached separately)

PREAMBLE TO BILLS OF QUANTITIES

1. The Bills of Quantities form part of the Contract Documents and are to be read in conjunction with the Conditions of Contract, Specifications and the Drawings.
2. The rates and prices inserted in the Bills of Quantities are to be the full inclusive costs of the works, described under the items, complete in place and in accordance with the specifications, including costs, expenses and profits which may be required in and for the construction of the works described, together with any temporary works and installations which may be necessary and all general risks, liabilities and obligations set forth or implied in the documents on which the contract
3. The quantities set forth in the Bills of Quantities are believed to represent the works to be carried out. There is no guarantee to the Contractor that he will be required to carry out the quantities of work indicated under any one particular item or groups of items in the Bills of Quantities. The basis of payment shall be the contractor's rates and the quantities of work actually done in fulfilment of his obligation under the contract.
4. The brief descriptions of items given in the Bills of Quantities are purely for the purpose of identification and in no way modify or supersede the detailed descriptions given in the Conditions of Contract, Standard or Special Specifications.
5. A price or rate shall be entered in ink against every item in the Bill of Quantities with the exception of items, which already have provisional sums, affixed thereto. The Tenderers are reminded that no "nil" or "included" rates or "lump-sum" discounts will be accepted. The rates for various items should include discounts if any. Tenderers who fail to comply will be disqualified.
6. Please note that all prices quoted should be inclusive of all Government taxes, duties and VAT.

TENDER NO KWS/OT/R&F/ 35 /2018-2019					
Routine Maintenance of Voi gate - Sala gate (E682) - 90.7KM					
Item	Description of Work Item	Unit	Quantity	Rate	Amount (Kshs)
01-80-026	Allow a prime cost sum for the REs miscellaneous account	PC SUM	80,000	1	80,000.00
01-80-027	Extra over 01-80-026 for profits and overheads	%	80,000		
01-80-028	Allow a prime cost sum for off road Environmental Mitigation	PC SUM	1	100,000.00	100,000.00
01-80-029	Extra over 01-80-028 for profits and overheads	%	100,000		
01-80-034	Allow a prime cost sum for HIV/AIDS awareness on site	PC SUM	1	12,000.00	12,000.00
05-50-006	Fill in soft material and compact	M ³	12,000		
08-60-009	Culvert Cleaning- Fully Blocked - 900mm	MT	60		
08-60-025	Culvert Installation 600 mm with surround. Rate to include backfilling as per specifications	METERS	21		
08-60-027	Culvert Installation 900 mm with surround. Rate to include backfilling as per specifications	METERS	14		
10-50-003	Light grading as instructed by the Engineer	M ²	532,200		
10-60-003	Gravel Patching	M ³	8,000		
A					
B					
	Total Carried Forward to Summary Page				

TENDER NO KWS/OT/R&F/ 35 /2018-2019					
Routine Maintenance of Voi gate - Sala gate (E682) - 90.7KM					
Item	Description of Work Item	Unit	Quantity	Rate	Amount (Kshs)
01-80-026	Allow a prime cost sum for the REs miscellaneous account	PC SUM	80,000	1	80,000.00
01-80-027	Extra over 01-80-026 for profits and overheads	%	80,000		
01-80-028	Allow a prime cost sum for off road Environmental Mitigation	PC SUM	1	100,000.00	100,000.00
01-80-029	Extra over 01-80-028 for profits and overheads	PC SUM	100,000		
01-80-034	Allow a prime cost sum for HIV/AIDS awareness on site	PC SUM	1	12,000.00	12,000.00
05-50-006	Fill in soft material and compact	M ³	12,000		
08-60-009	Culvert Cleaning- Fully Blocked - 900mm	MT	60		
08-60-025	Culvert Installation 600 mm with surround. Rate to include backfilling as per specifications	METERS	21		
08-60-027	Culvert Installation 900 mm with surround. Rate to include backfilling as per specifications	METERS	14		
10-50-003	Light grading as instructed by the Engineer	M ²	532,200		
10-60-003	Gravel Patching	M ³	8,000		
A	SUB TOTAL				
B	ADD 16% VAT				
	Total Carried Forward to Summary Page				

TENDER NO KWS/OT/R&F/35 /2018-2019		
Summary Page		
Item	Description of Work Item	Amount(Kshs)
1	Routine Maintenance of Voi town - Voi gate (E682) - 4.3KM	
2	Routine Maintenance of Voi gate - Sala gate (E682) - 90.7KM	
A	SUB TOTAL	
B	ADD 16% VAT	
	Total Carried Forward to Form of Tender(A+B)	

SECTION VII:
SECTION VIII – STANDARD FORMS

1. FORM OF AGREEMENT

THIS AGREEMENT is made on the.....day ofbetween the **Kenya Wildlife Service** of P. O. Box 40241-00100, Nairobi, Kenya hereinafter called "the Procurement Entity" of the one part And

.....of.....

 hereinafter called "the Contractor" of the other part.

WHEREAS the Employer is desirous that certain works should be executed, viz **Routine Maintenance works in section of Road**.....in

.....National Park.

to.....

and has accepted a BID by the Contractor for the execution completion and maintenance of such works on the road sections as defined hereafter.

NOW THIS AGREEMENT WITNESSETHES as follows:

In this agreement words and expressions shall have the same meanings as are respectively assigned to them in the Conditions of Contract hereinafter referred to.

The following documents shall be deemed to form and be read and construed as part of this Agreement, viz.:

- ❖ The Contract Agreement;
- ❖ The Letter of award by the Procurement Entity
- ❖ The Letter of Acceptance by the Contractor;
- ❖ The Form of Contract and Appendix to the Form of Contract;
- ❖ The Conditions of Contract Part I;
- ❖ The Conditions of Contract Part II;
- ❖ The Standard Specification for Road and Bridge Construction, 1986;
- ❖ The Special Specifications;
- ❖ The Drawings;
- ❖ The priced Bill of quantities;
- ❖ Conditions to the Contract and instructions to the Contractor;

All aforesaid documents are hereinafter referred to as "The Contract".

In consideration of the payment to be made by the Procurement Entity to the Contractor, the Contractor hereby covenants with the Procurement Entity to execute, complete and maintain the works in conformity in all respects with the provisions of the Contract.

The Procurement Entity hereby covenants to pay the Contractor in consideration of the execution, completion and maintenance of the works for the Contract Price at the times and in the manner prescribed by the Contract.

IN WITNESS HEREOF the parties that have caused this Agreement to be executed thisday of

SEALED with the Common Seal of Kenya Wildlife Services (KWS).

By the said Employer:
(Director, Kenya Wildlife Service)
For and on behalf of the said Employer

In the presence of:
(Name and Designation of Witness)

.....
(Signature of Witness)

.....
(Address of witness)

SEALED with the Common Seal of
.....
(Insert the Name of Tender)

By the said Contractor:
(Managing Director)

In the presence of:
(Name and Designation of Witness)

.....
(Signature of Witness)

.....
(Address of witness)

Adjudicator’s Agreement

Identification of Project:

.....
(the “Project”)

Name and address of the Employer:

.....
(the “Employer”)

Name and address of the Contractor:

.....
(the “Contractor”)

Name and address of the Adjudicator:

.....
(the “Adjudicator”)

Whereas the Employer and the Contractor have entered into a contract (“the Contract”) for the execution of the Project and wish to appoint the Adjudicator to act as adjudicator in accordance with the Rules for Adjudication [“the Rules”].

The Employer, Contractor and Adjudicator agree as follows:

1. The Rules and dispute provisions of the Contract shall form part of this Agreement.
2. The Adjudicator shall be paid:

A retainer fee ofper calendar month
(where applicable)

A daily fee of

Expenses (including the cost of telephone calls, courier charges, faxes and telexes incurred in connection with his duties; all reasonable and necessary travel expenses, hotel accommodation and subsistence and other direct travel expenses).
Receipts will be required for all expenses.

- 3. The Adjudicator agrees to act as adjudicator in accordance with the Rules and has disclosed to the Parties any previous or existing relationship with the Parties or others concerned with the Project.
- 4. This Agreement shall be governed by the law of
- 5. The Language of this Agreement shall be

SIGNED BY

For and on behalf of the Employer in the presence of

Witness
Name
Address
Date

SIGNED BY

For and on behalf of the Contractor in the presence of

Witness
Name
Address
Date

SIGNED BY

For and on behalf of the Adjudicator in the presence of

Witness
Name
Address
Date

2. **FORM OF PERFORMANCE BANK GUARANTEE (UNCONDITIONAL)**

To:

Kenya Wildlife Service (KWS)

P. O. Box 40241-00100,

Nairobi,

Kenya

1. WHEREAS
(hereinafter called the Contractor) has undertaken in pursuance of contract No. RD:
.....dated.....to execute the
.....(hereinafter called the "Contract")

2 AND WHEREAS it has been stipulated by you in the said Contract that the Contractor shall furnish you with a Bank Guarantee by a recognized bank for the sum specified in the Appendix to Form of Tender as security for compliance with his obligations in accordance with the Contract;

3. AND WHEREAS we have agreed to give the Contractor such a Bank Guarantee;

1. NOW THEREFORE we (name of Bank)

.....
(hereinafter called "the Bank") hereby affirm that we are the Guarantor and responsible to you on behalf of the Contractor up to a total of Kshs.....

Amount in words.....and we undertake to pay to you, upon your first written demand and without cavil or argument, any sum or sums within and up to the limits as aforesaid without your needing to prove or show grounds or reasons for the sum specified therein.

We hereby waive the necessity of you demanding the said debt from the Contractor before presenting us with the demand.

We further agree that no change or addition to or other modification of the terms of the Contract or of the Works to be performed there under or of any of the Contract Documents which may be made between you and the Contractor shall in any way release us from any liability under this Guarantee and we hereby waive notice of any such change, addition or modification

This Guarantee shall be valid until 28 days after issuing of the Defects Liability Certificate.

AUTHORISED SIGNATORY FOR THE BANK.....

Name of bank.....

Address.....

Date

LETTER OF CREDIT

To

**The Director General, NAIROBI
Kenya Wildlife Service,
P.O. Box 40241 - 00100**

RE: LINE OF CREDIT FOR (CONTRACT DETAILS)

Reference is made to inquiry from our Customer of P.O. Box in regard to line of Credit for financing above tender. We wish to state as following.

1. M/S(name of tender) has satisfactorily conducted an account dominated in Kenya Shillings with us for a period of more than one year.
2. Currently the above named Customer enjoys
 - a) A Bank Over draft facility of Kshs
 - b) A bank loan of Kshs
3. As per the prudential norms for Financing which MUST be fulfilled by our customer, we are in a position to provide a line of credit to M/s (tenderer name) for Kshs

This information is given in strict confidence, and without any guarantee or liability on the part of the bank or any of its officers.

Yours Faithfully

Bank Authorised Signatory